

Minha apostila de Alfabetização

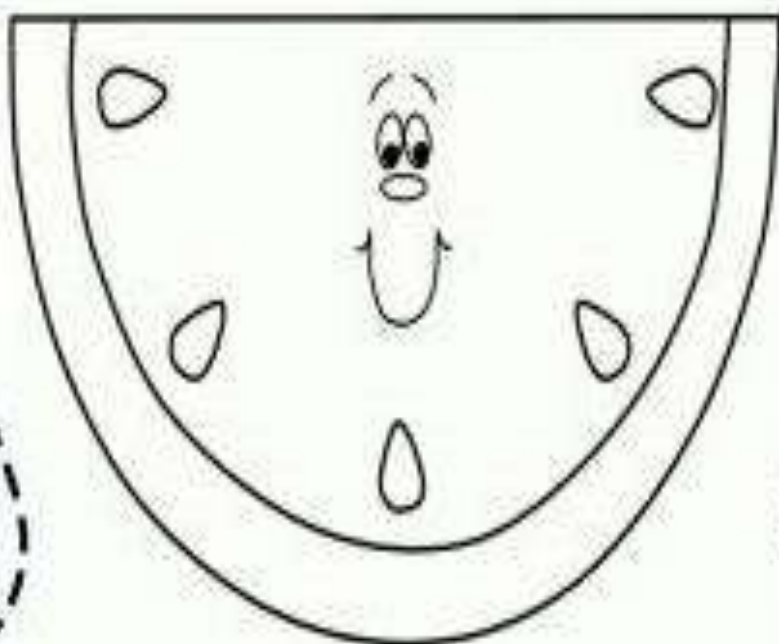

Coordenação motora fina

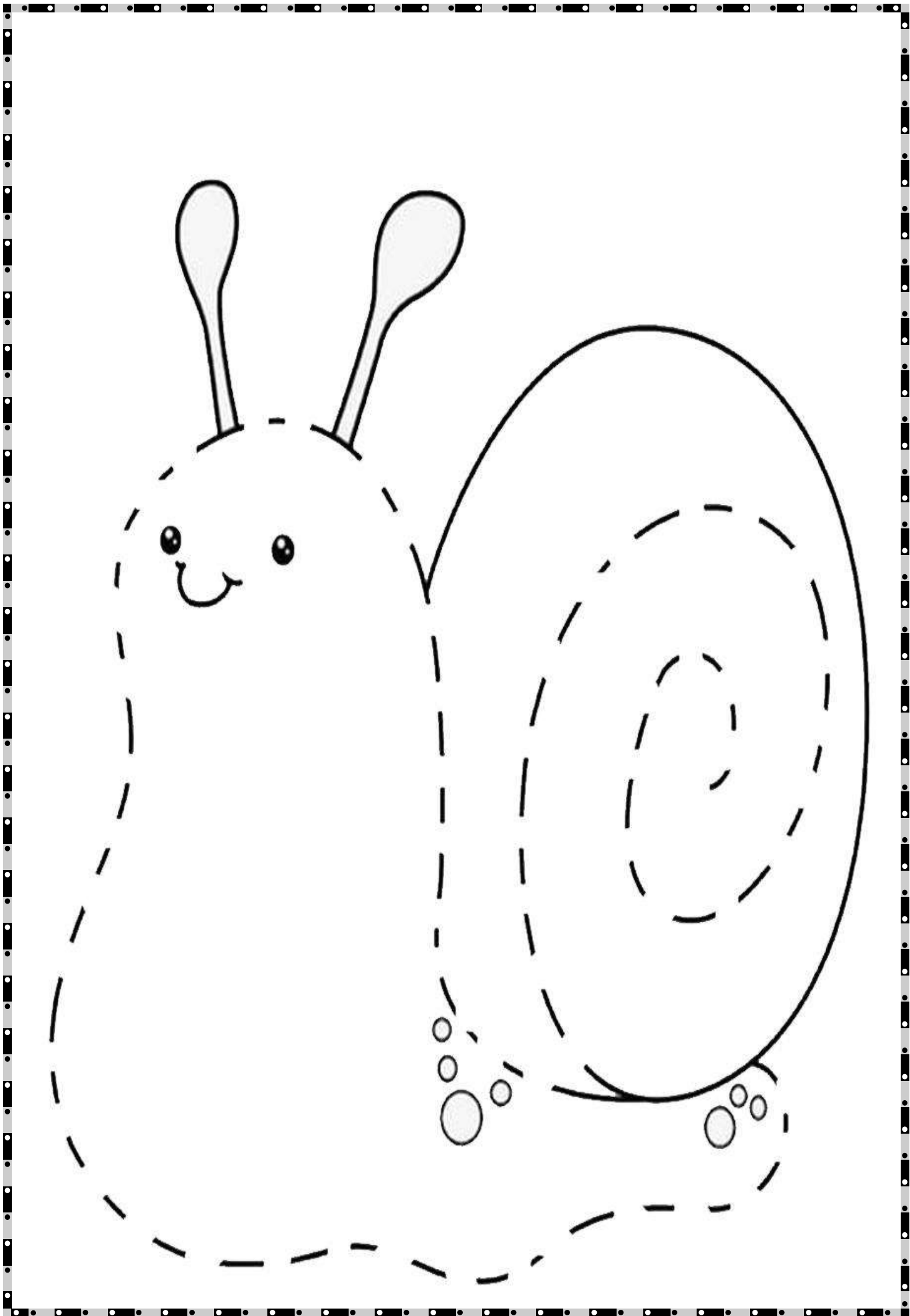



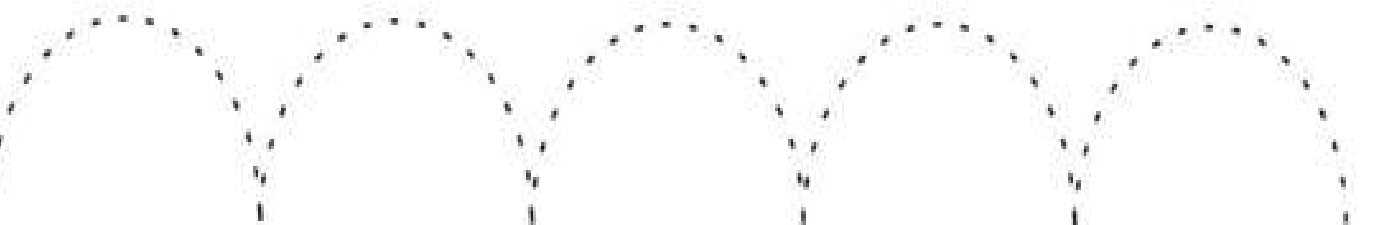
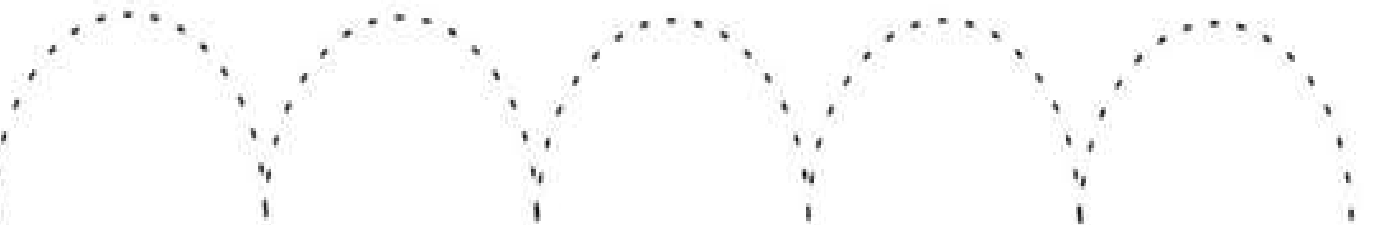
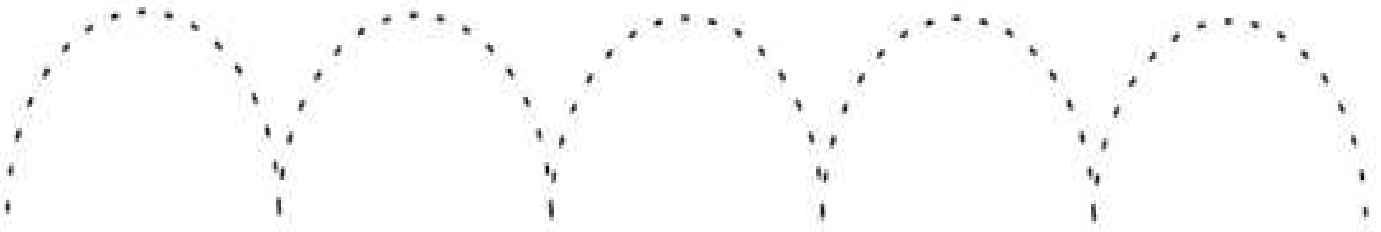
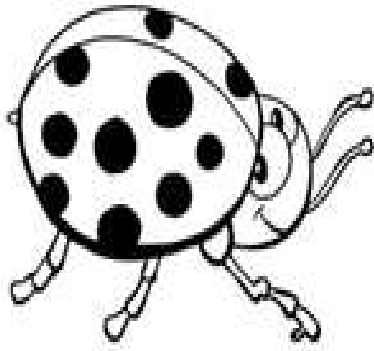

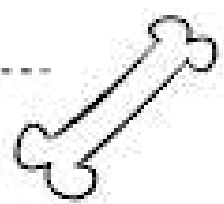
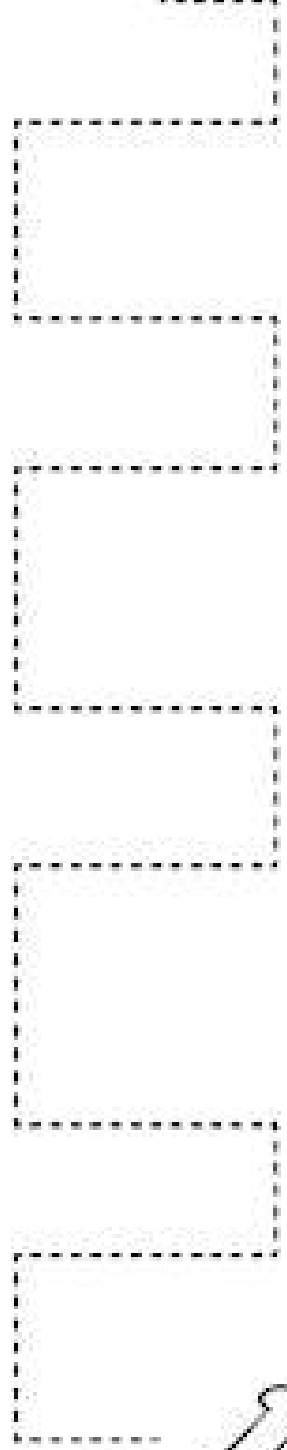
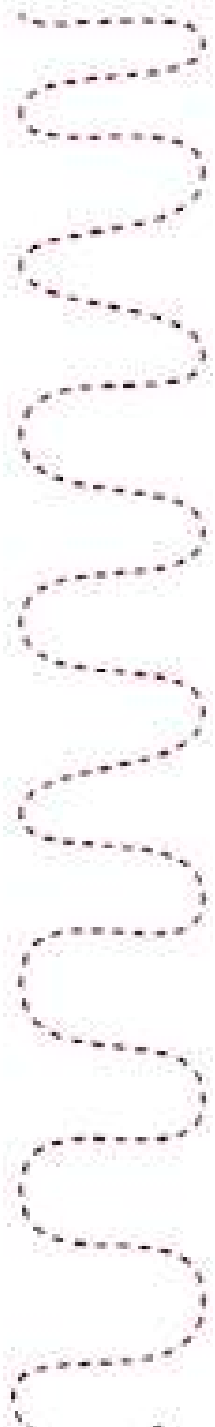
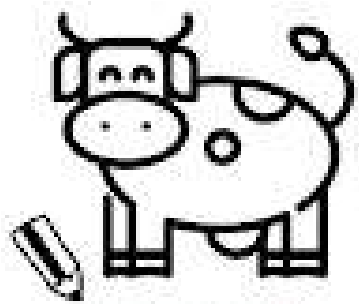
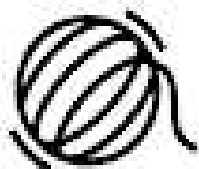
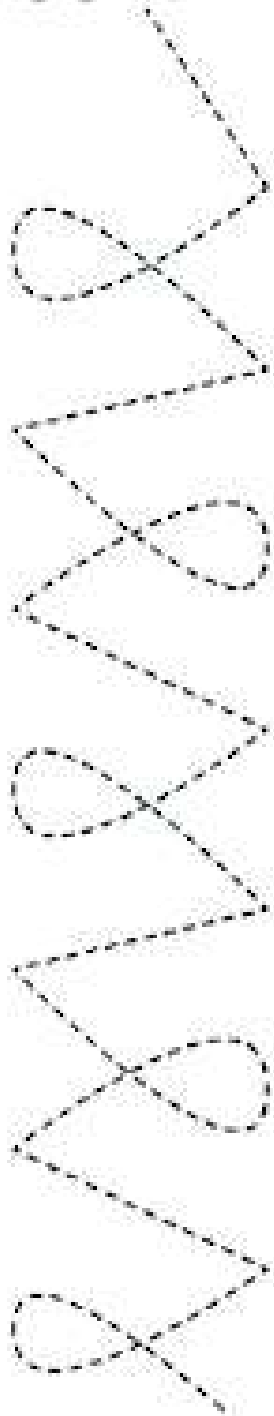
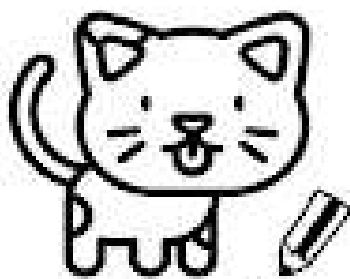

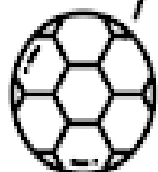
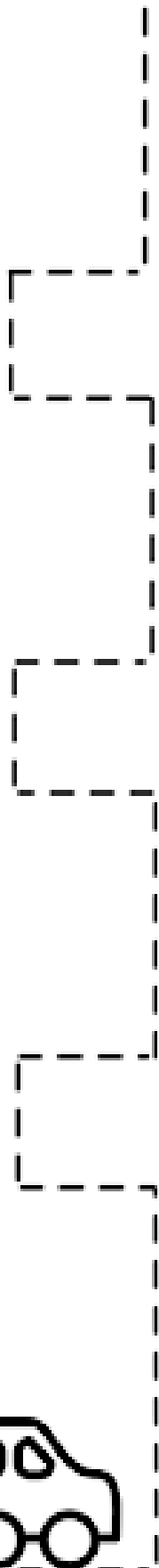
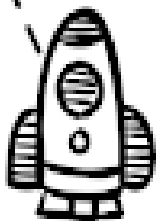
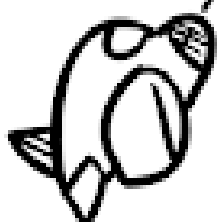

ESCREVA SEU NOME:

AGORA, PINTE AS LETRAS QUE VOCÊ USOU PARA
ESCREVER SEU NOME:



LIGUE A FIGURA À SUA LETRA INICIAL:

B



D

M



A

V



F

P



O

U



R

C



T

E



L

COMPLETE A SERPENTE COM AS LETRAS DO ALFABETO:

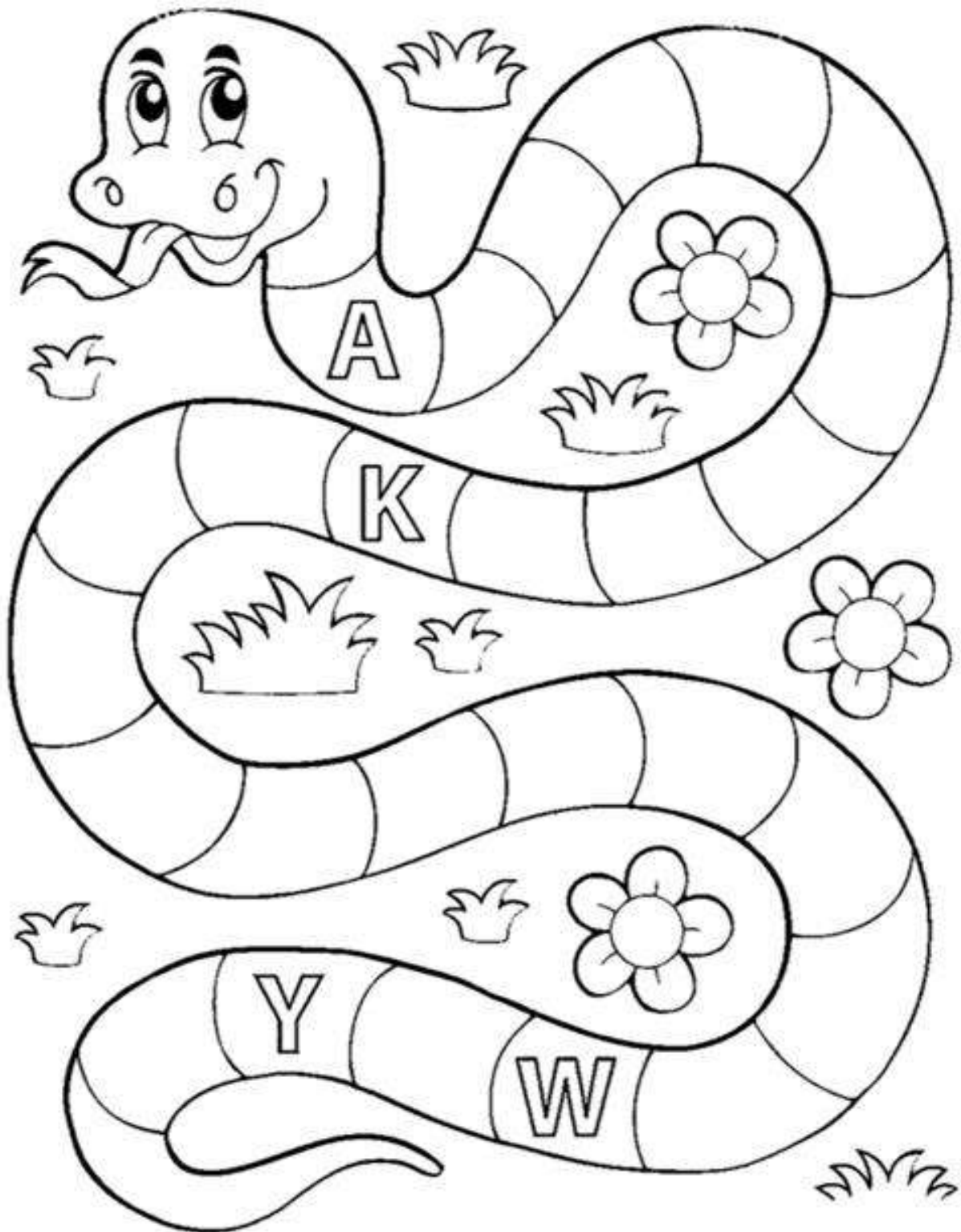

PINTE A VOGAL INICIAL DAS FIGURAS:

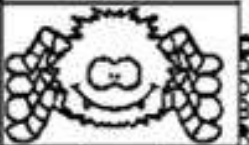

A hedgehog with a smiling face, surrounded by leaves. The word "Hedgehog" is written vertically on the right side.

A E O



A small cat sitting down.

I U E



A door with a handle and a keyhole.

U A O



A shield with a cross in the center.

E U O



A school bus.

E I O



A teddy bear sitting down.

O A U



A fishbowl with two fish inside.

I A O



A playground slide.

O E I



A human eye.

O A U



A pineapple.

E A I



The number 1.

I A U



A sheep.

A O E



A five-pointed star.

A U E



A diamond ring.

O A U



A bunch of grapes.

A U I



A sword.

U E A

PINTE A VOGAL FINAL DAS FIGURAS:



O E U



I U O



E I A



A E U



I U A



U I E



O I E

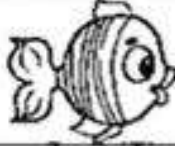

O E A



O A E



E A I



I U O



A I U



A U E



O A U



A U I



U E A

COMPLETE COM A PRIMEIRA LETRA DE CADA PALAVRA:



.....BACAXI



.....LEFANTE



.....NDIO



.....VO



.....VA



.....LHOS



.....RSO



.....VIÃO

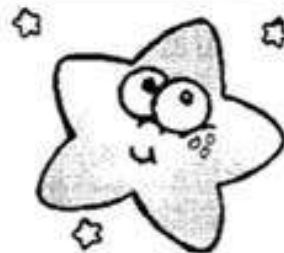

.....STRELA

A

E

I

O

U

COMPLETE COM AS VOGAIS FALTOSAS:

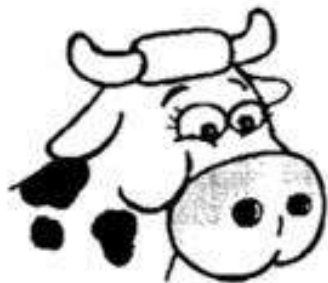

V.....C.....



V.....L.....



B.....L.....

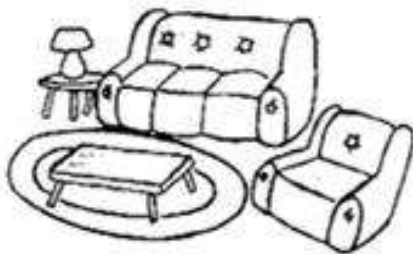

S.....L.....



.....V.....



B.....T.....



C.....P.....



L.....V.....



D.....D.....

A

E

I

O

U

ENCONTROS VOCÁLICOS

DITADO RECORTADO



EI!

UI!

OI!

AI!

AU!

IOIÔ!

Cubra as vogais:



A E I O U

A E I O U

a e i o u



a e i o u

a e i o u



Encontros Vocálicos

Hora da leitura



ABC

A E I O U

Encontros

Vocálicos



Eu Eu
eu eu



Oi Oi
oi oi



Ei Ei
ei ei



Ui Ui
ui ui



Eia Eia
eia eia



Au Au
au au

AS VOGAIS FORMAM PALAVRINHAS
QUANDO SE JUNTAM!
LIGUE AS PALAVRAS A CENA CORRETA E AS
ESCREVA DENTRO DOS BALÕES:

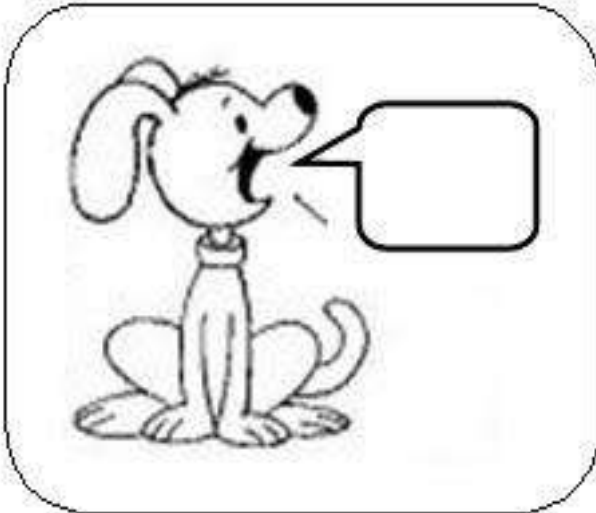

AI

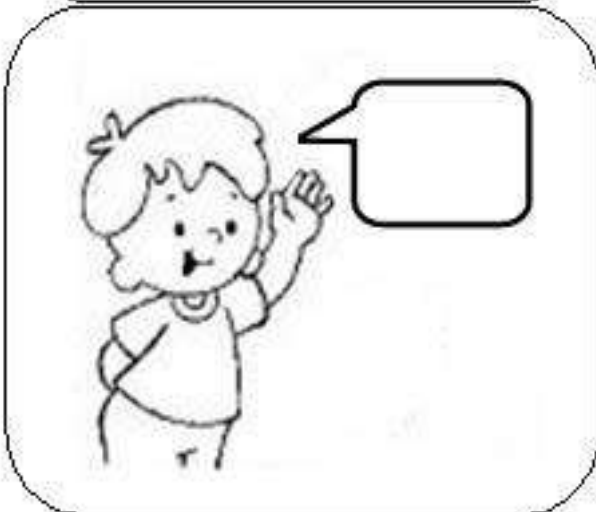

AU



OI

JUNTE AS VOGAIS E FORME OS ENCONTROS VOCÁLICOS. LEIA.

$$A + I = \text{ } \bigcirc$$

$$E + U = \text{ } \bigcirc$$

$$U + I = \text{ } \bigcirc$$

$$A + U = \text{ } \bigcirc$$

$$O + I = \text{ } \bigcirc$$

$$E + I = \text{ } \bigcirc$$

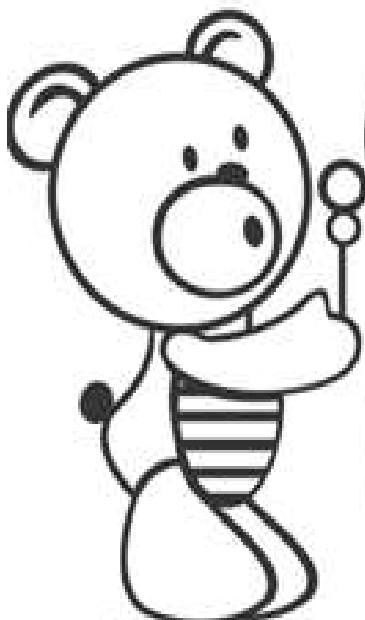



VOGAIS JUNTINHAS

FORMAM PALAVRINHAS

MEU QUERIDO(A) JUNTE AS VOGAIS E FORME OS ENCONTROS VOCÁLICOS.

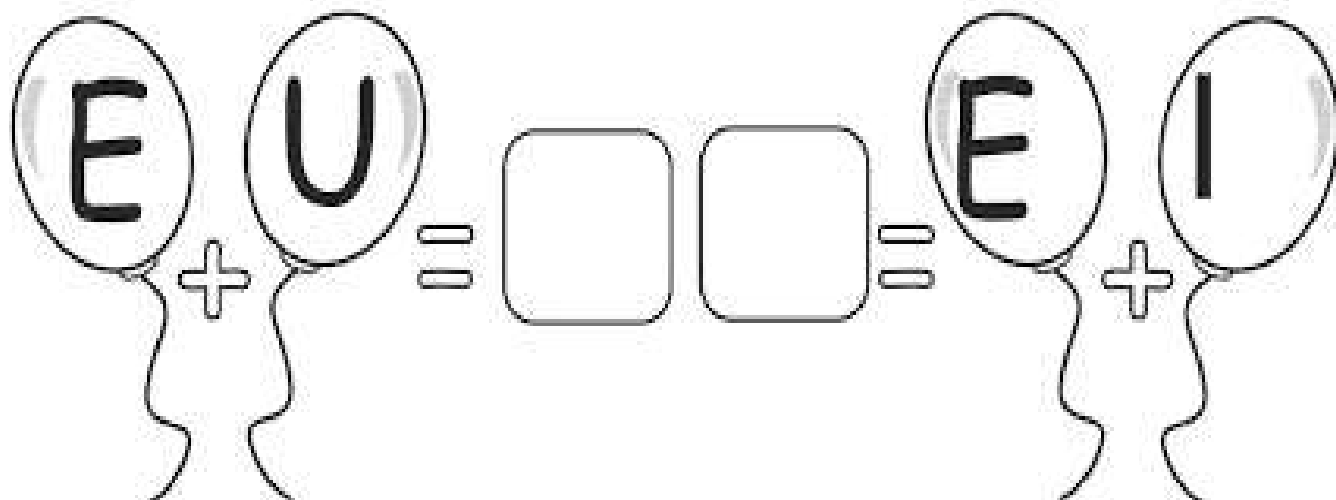
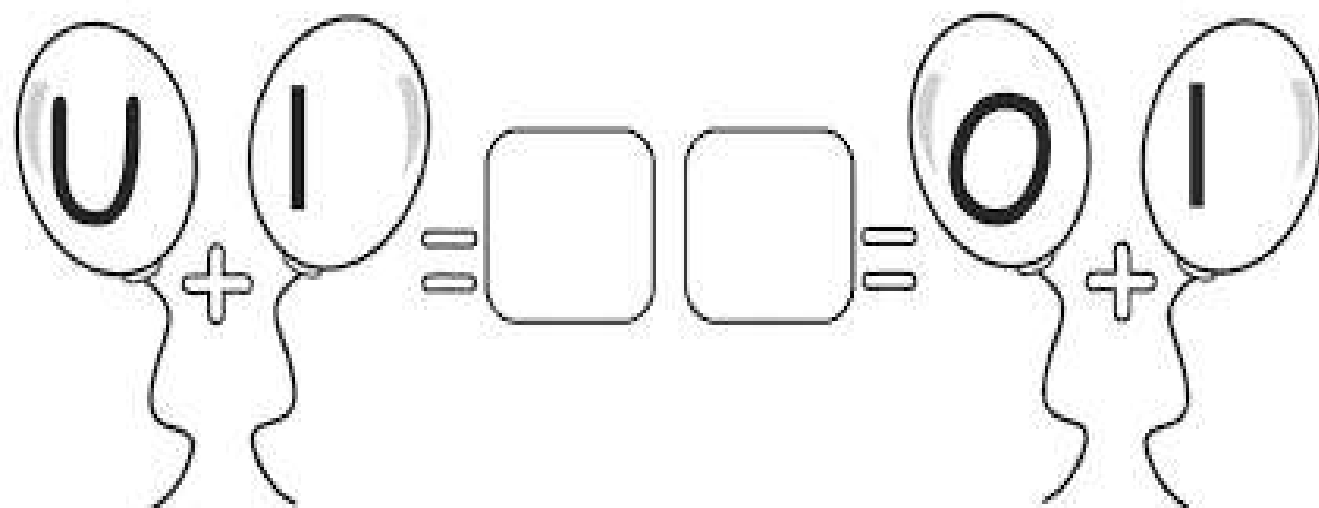
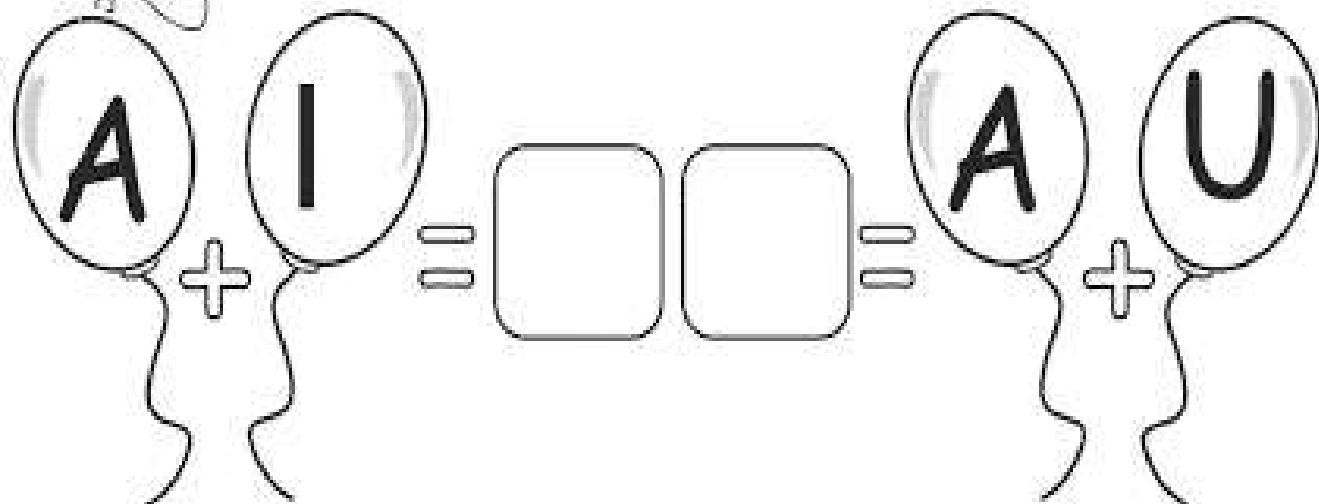

LEITURA

b B

b B



BOLA

ba- be- bi- bo- bu

BA- BE- BI- BO- BU

ba- be- bi- bo- bu

Ba- Be- Bi- Bo- Bu

BOLA	BOCA	BONÉ
BOLO	BAÚ	BOA
BICO	BANANA	BATATA
BONECA	BEXIGA	BEBÊ
BULE	BOI	BALÃO

O BEBÊ GOSTA DA BOLA.



BA BE BI BO BU BÃO

ba be bi bo bu bão

COMPLETE AS PALAVRAS COM AS SÍLABAS
CORRESPONDENTES.

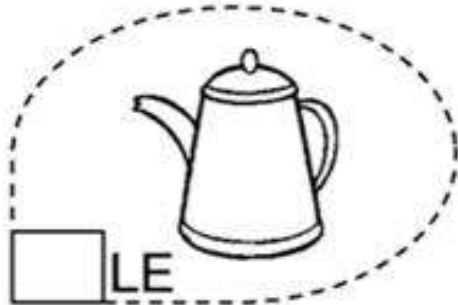
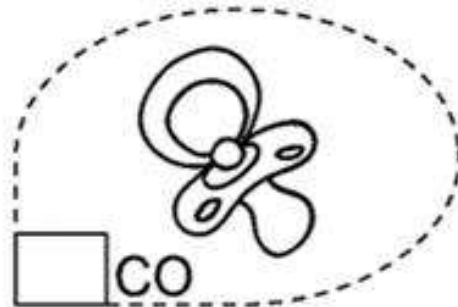

Cubra as famílias silábicas da letra B b.

Ba Be Bi Bo Bu

Ba Be Bi Bo Bu

ba be bi bo bu

ba be bi bo bu





Ba - Be - Bi - Bo - Bu

ba - be - bi - bo - bu

bala - bebê - bicicleta

boneca - bone



CAÇA-PALAVRAS

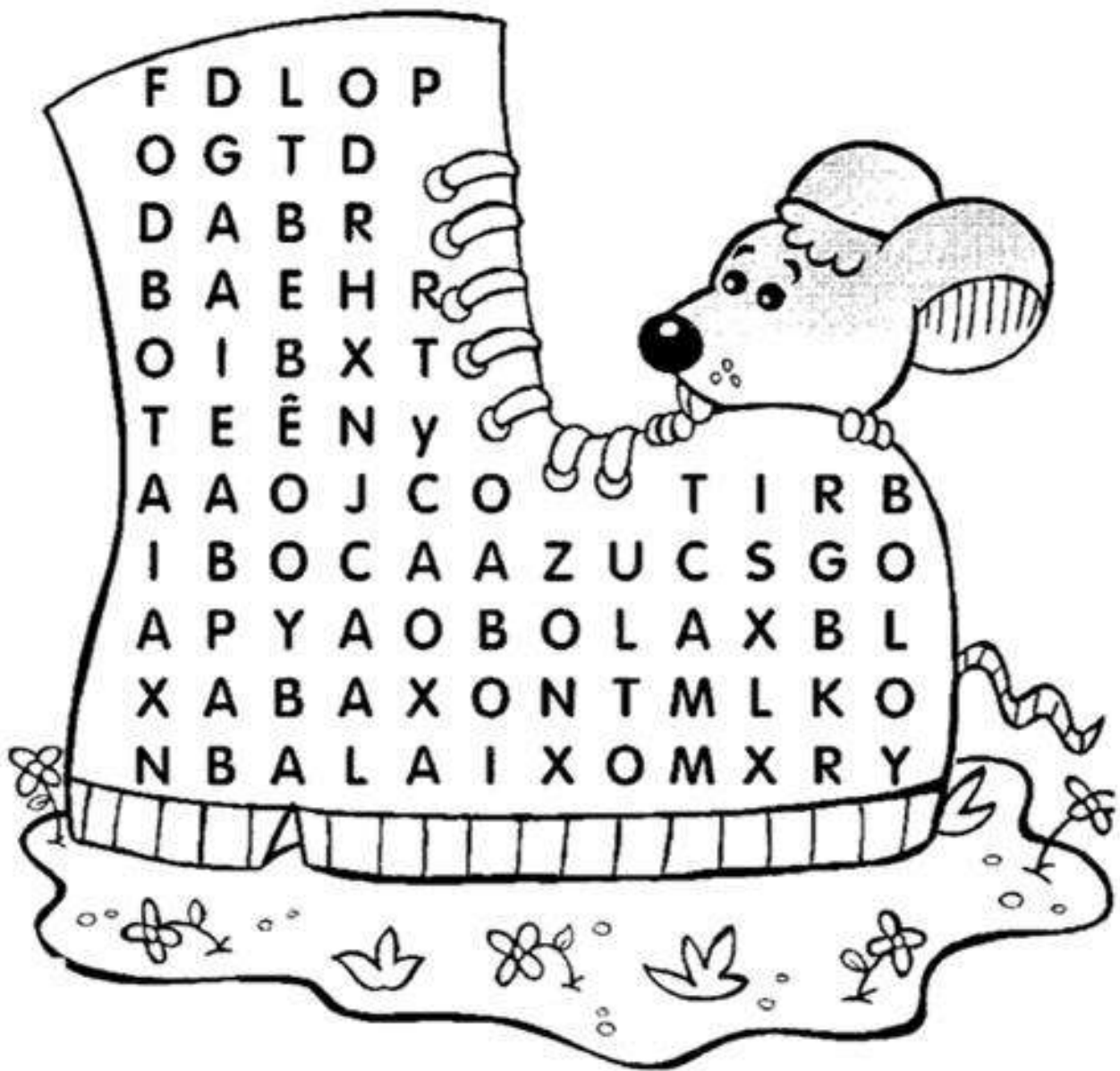

BOTA, BALA, BOLA, BOCA, BOI,
ABA, BEBÊ, BOLO

COMPLETE O NOME DAS FIGURAS COM AS SÍLABAS ABAIXO;
E PREENCHA A CRUZADINHA:



___ LO



___ NECA



___ NANA

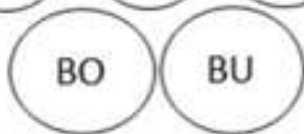

___ TA



___ LÃO



___ LEIA



___ NÉ

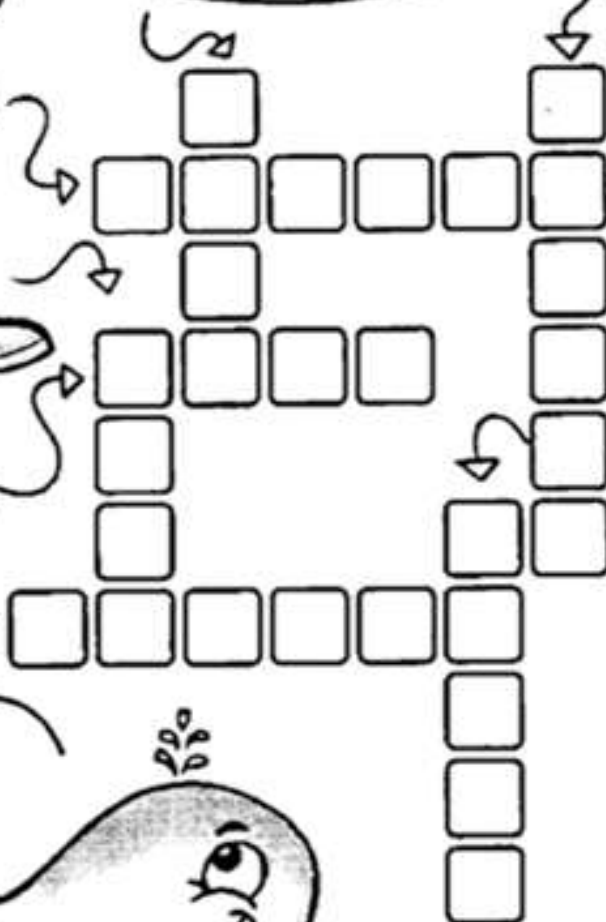

LEITURA



CORUJA

ca- ce- ci- co- cu

CA- CE- CI- CO- CU

ca- ce- ci- ce- cu

Ca- Ce- Ci- Co- Cu

CAIU	CORUJA	CEBOLA
CABO	CINEMA	CIPÓ
CANOA	CENOURA	CABIDE
CARRO	CEDO	CAMISA
CAVALO	CIDADE	CASA

A CORUJA É UM ANIMAL INTELIGENTE.



CA CO CU CÃO CE CI

ca co cu cão ce ci

COMPLETE AS PALAVRAS COM AS SÍLABAS
CORRESPONDENTES.

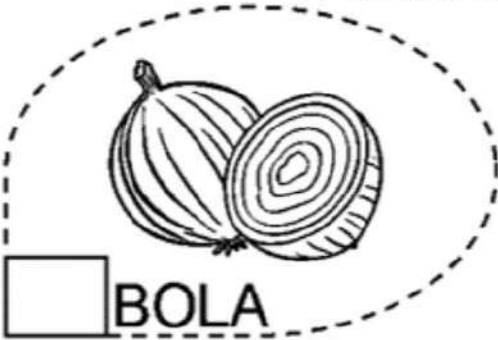

BOLA

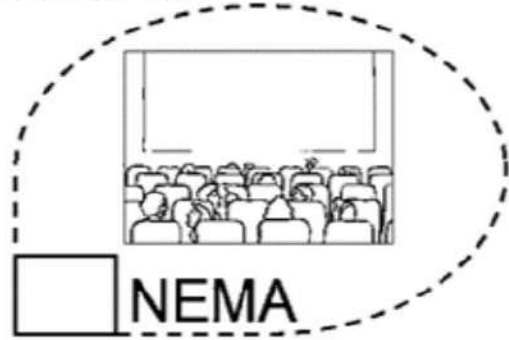

NEMA



BRA



GONHA



ECA



RUJA



CHORRO

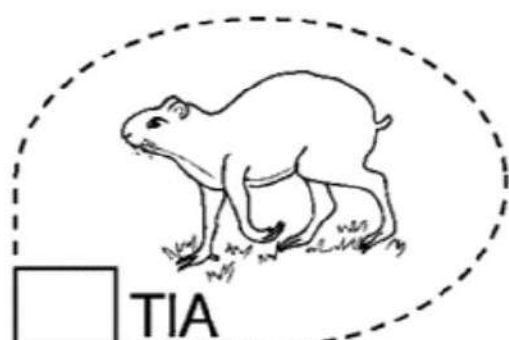

TIA

Cubra as famílias silábicas da letra C c.

ca ca cu

ca ci

ca cu

ca ci

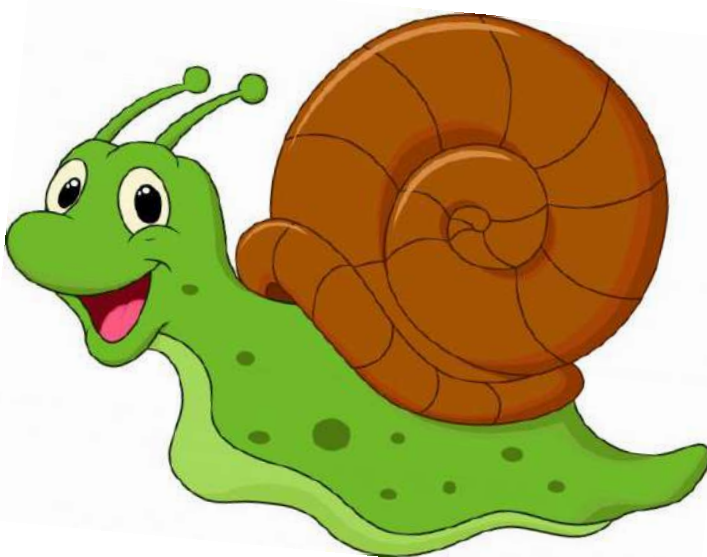



Ca - Ce - Ci - Co - Cu

ca - ce - ci - co - cu

casa - cebola - cinema

comida - cueca



PINTE TODAS AS FIGURAS QUE COMEÇAM COM CA:



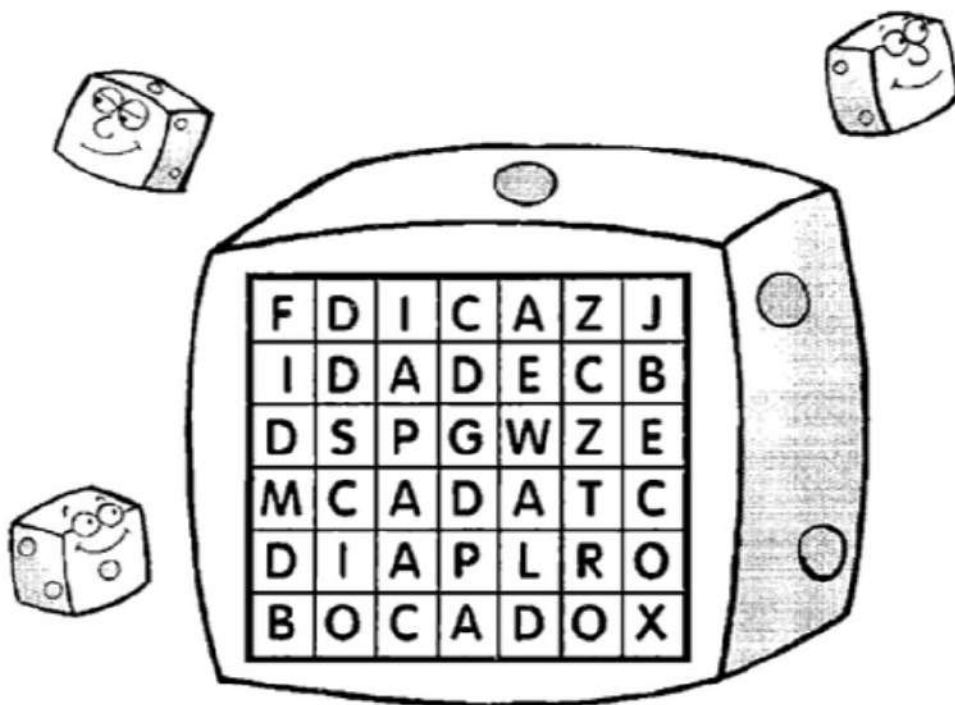

DICA CADA BOCADO BECO
IDADE DIA

MONTE AS PALAVRAS:

CA	+	CO	=		CA	+	BO	=	
CO	+	CA	=		CA	+	BE	=	
CU	+	CA	=		CA	+	CÁ	=	
CU	+	CO	=		CO	+	CO	=	
BO	+	CA	=		O	+	CA	=	
BE	+	CO	=		E	+	CA	=	
BI	+	CO	=		CA	+	I	=	

LEITURA



DADO

da- de- di- do- du
DA- DE- DI- DO- DU
da- de- di- do- du
Da- De- Di- Do- Du

DEDO	DATA	DUVIDO
DIA	DICA	DAVI
DOCE	DAMA	DEITADO
DADO	DONO	DELE
DOMINÓ	DURO	DOZE

DANILO GOSTA DE JOGAR DADOS.

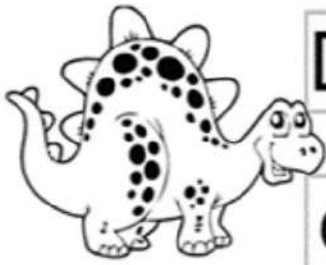

DA

DE

DI

DO

DU

DÃO

da

de

di

do

du

dão

COMPLETE AS PALAVRAS COM AS SÍLABAS
CORRESPONDENTES.

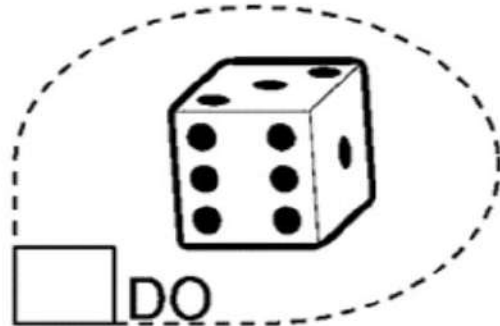

Da De Di Do Du

Da De Di Do Du

da de di do du

da de di do du





Da - De - Di - Do - Du

da - de - di - do - du

dado - dede - dimonzauro

doce - duende



PINTE AS SÍLABAS QUE FORMAM O NOME DOS
DESENHOS:



DE	NO	DO	SA
----	----	----	----



SA	DA	SO	DO
----	----	----	----



DI	FA	NO	A
----	----	----	---

PINTE AS SÍLABAS DA – DE – DI – DO – DU DAS PALAVRAS:



BODE



DINO



VEADO



ESPADA



DUENDE

BODE

CADEADO

DADO

DEDO

CABIDE

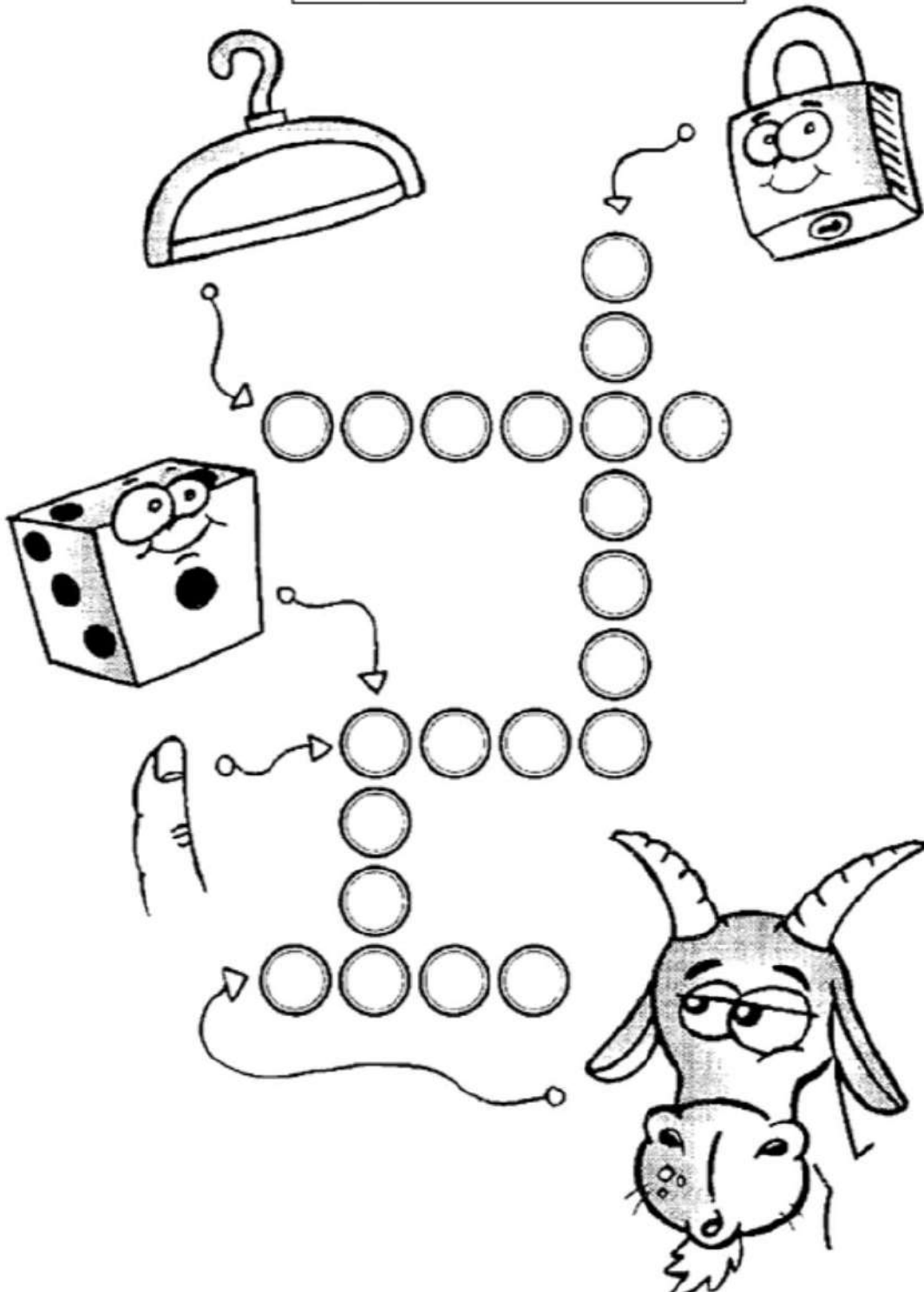

LEITURA



FOCA

fa- fe- fi- fo- fu
FA- FE- FI- FO- FU
fa- fe- fi- fo- fu
Fa- Fe- Fi- Fo- Fu

FADA	FITA	FELICIDADE
FEIO	FIGO	FOGO
FICA	FOTO	FAMÍLIA
FOCA	FUMAÇA	FEIJÃO
FERIDA	FOFO	FOME

A FOCA É DIVERTIDA.



FA FE FI FO FU FÃO

fa fe fi fo fu fão

COMPLETE AS PALAVRAS COM AS SÍLABAS
CORRESPONDENTES.

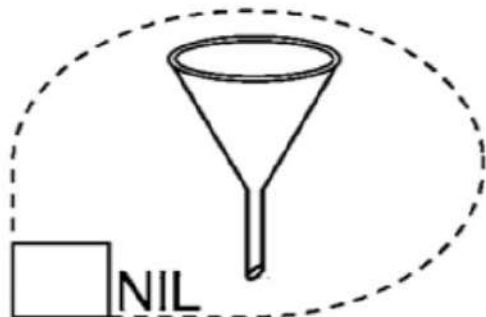

Cubra as famílias silábicas da letra ɜ ʝ.

ɜa ɜe ɜi ɜo ɜu

ɜa ɜe ɜi ɜo ɜu

ʝa ʝe ʝi ʝo ʝu

ʝa ʝe ʝi ʝo ʝu





Fa - Fe - Fi - Fo - Fu

fa - fe - fi - fo - fu

fada - felicidade - fimo

faca - fumaça



JUNTE OS SÍMBOLOS E FORME PALAVRAS:

DITADO SIMBÓLICO

FO

FI

FÁ

FU

FÉ

CA

CA

FO

LA

GÃO

BÁ

VE

SO

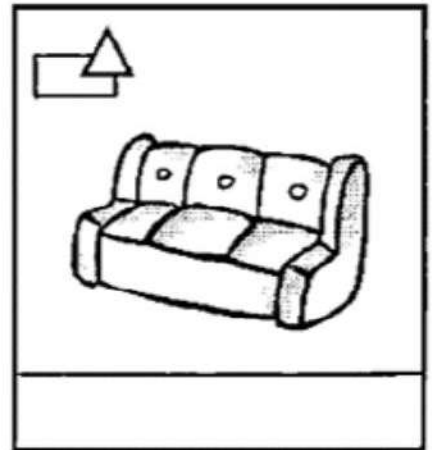
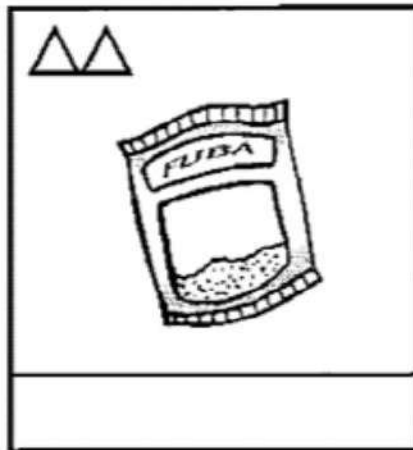
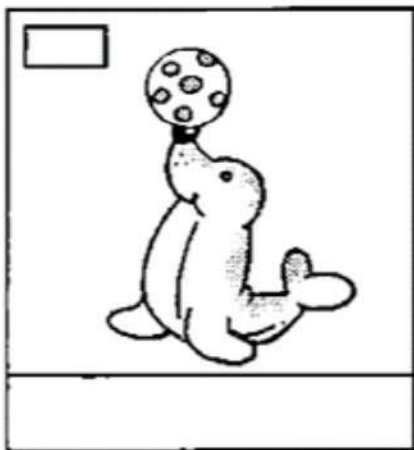
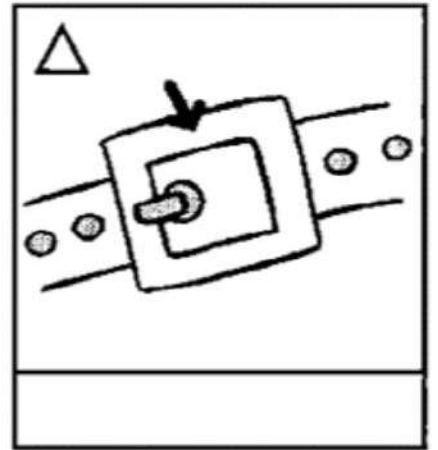
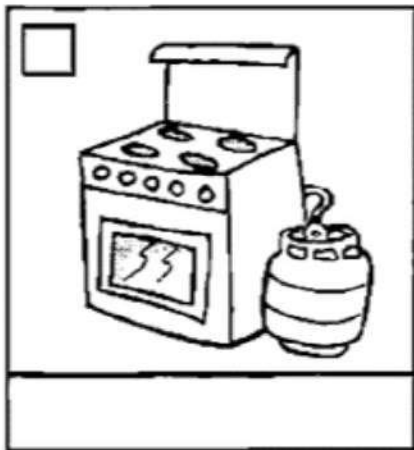

OBA! CAÇA PALAVRAS

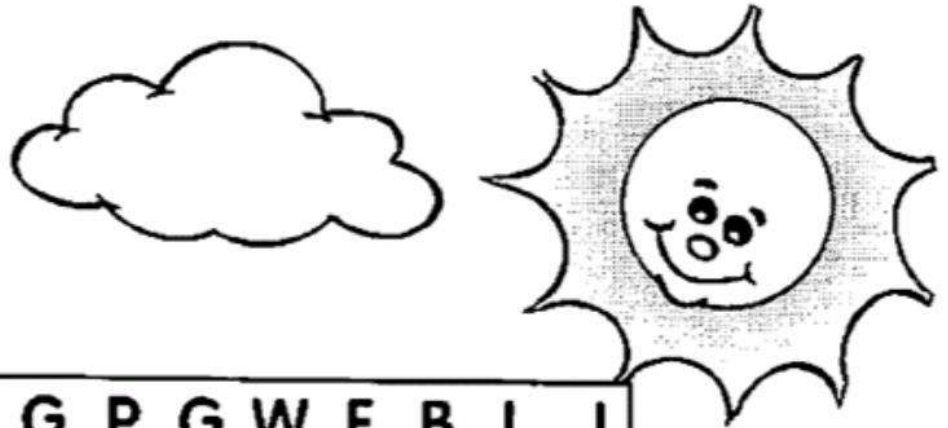

C	G	P	G	W	F	B	L	J
F	R	T	R	R	O	Q	F	H
R	Q	L	B	L	C	F	Á	G
Q	W	N	S	F	A	I	B	F
W	T	S	H	W	B	A	I	W
M	A	B	A	F	A	D	O	J
T	P	A	F	E	I	O	K	G
N	W	F	L	Q	S	R	V	T
M	W	O	W	F	I	C	A	Q



FOCA FEIO BAFO FICA
ABAFADO FÁBIO FIADO

LEITURA



GATO

ga- ge- gi- go- gu

GA- GE- GI- GO- GU

ga- ge- gi- go- gu

Ga- Ge- Gi- Go- Gu

GAVETA	GOMA	GUGU
GELO	GATO	GEADA
GOIABA	GILETE	GALERIA
GEMA	GORILA	GIGANTE
GIZ	GELADO	GOLA

O GATO É MUITO FOFO.



GA

GO

GU

GÃO

GE

GI

ga

go

gu

gão

ge

gi

COMPLETE AS PALAVRAS COM AS SÍLABAS CORRESPONDENTES.



LADEIRA

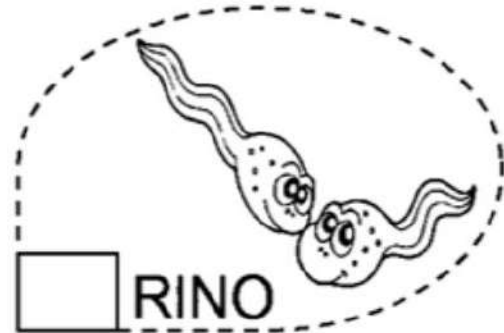

RINO

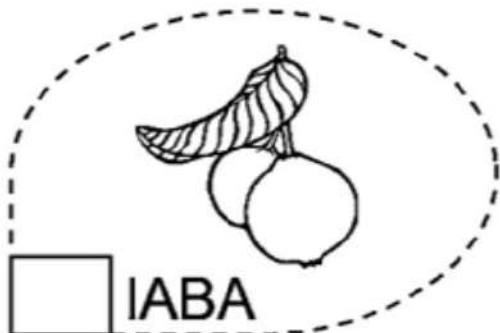

IABA



LINHA



LÃO

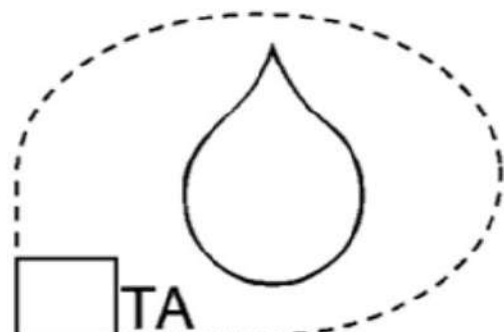

TA



RASSOL



RILA

Cubra a família silábica da letra G g.

Ga Ga Gu

Ge Gi

ga ga gu

ge gi





Ga — Ge — Gi — Gg — Gu

ga — ge — gi — gg — gu

gate — geladeira — girafa

goiaba — gulosa



JUNTE AS SÍLABAS DE ACORDO COM AS FORMAS GEOMÉTRICAS E FORME PALAVRAS:

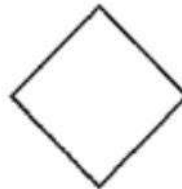
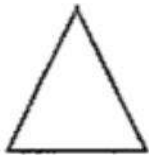
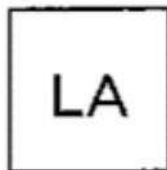
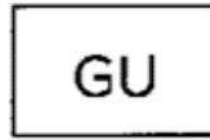
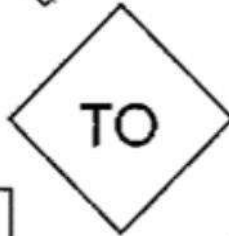
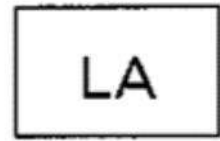

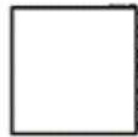
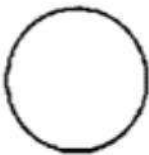

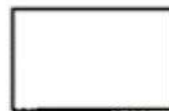
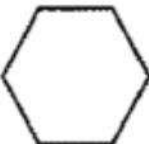

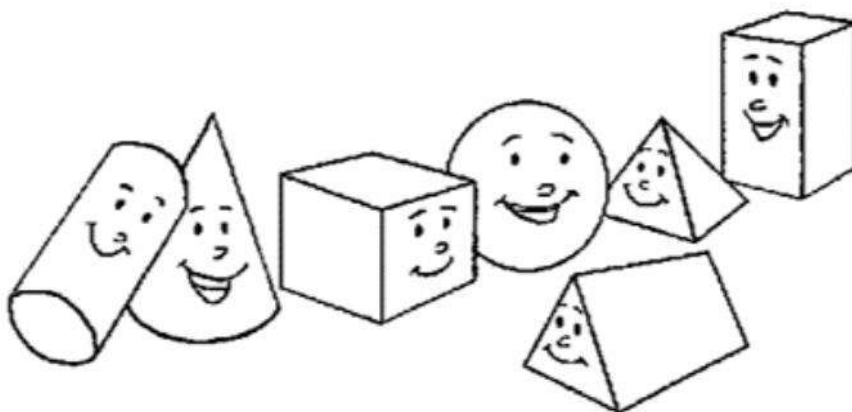

DITADO RECORTADO

RECORTE AS PALAVRAS ABAIXO E COLE-AS NA FIGURA CORRESPONDENTE:

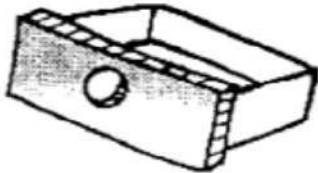

COGUMELO	GAVETA	FIGO
GATO	GALO	GOTA
GOIABA	FOGÃO	GAIOLA

LEITURA

h H
h H



HIPOPÓTAMO

ha- he- hi- ho- hu
HA- HE- HI- HO- HU
ha- he- hi- ho- hu
Ha- He- Hi- Ho- Hu

HORA	HIENA	HERDEIRO
HIGIENE	HOTEL	HELICÓPTERO
HUMANO	HOMEM	HIPOPÓTAMO
HARPA	HELENA	HERANÇA
HOJE	HÉLIO	HOMEM

VI UM HIPOPÓTAMO NA ÁGUA.



HA HE HI HO HU HÃO

ha he hi ho hu hão

COMPLETE AS PALAVRAS COM AS SÍLABAS CORRESPONDENTES.

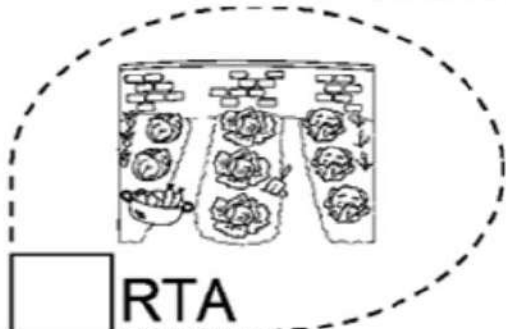

RTA

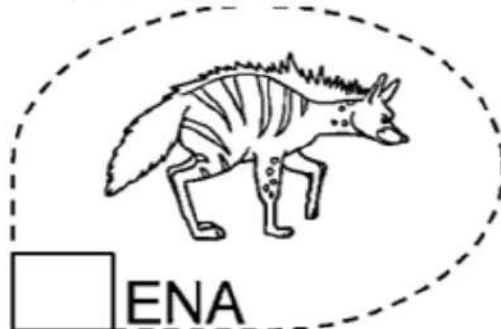

ENA



RPA



LOFOTE



RA



TEL



LÍCOPTERO



POPÓTAMO

Cubra a família silábica da letra K k.

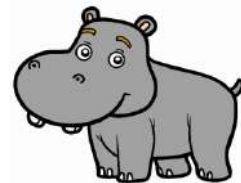

Ka Ke Ki Ko Ku

ka ke ki ko ku

Ka Ke Ki Ko Ku

ka ke ki ko ku

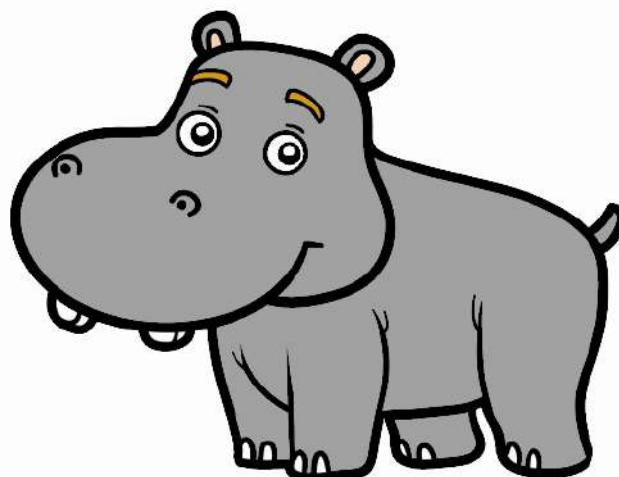
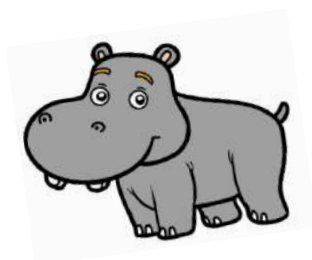



Ha - He - Hi - He - Hu

ha - he - hi - he - hu

harmenia - helicóptero - hiema

homem - humano



DE OLHO NAS PALAVRAS

PROCURE NO CAÇA-PALAVRAS:

HIGIENE	HONESTO	HÁLITO	HEROI	HIENA
HABITAÇÃO	HUMOR	HÉLIO	HOMEM	HERANÇA
HELENA	HORIZONTE	HOTEL	HOJE	HÓSPEDE

C	O	Q	H	I	E	N	A	Z	E	Ã	O
H	O	T	E	L	H	E	R	A	N	Ç	A
Ô	H	I	G	I	E	N	E	X	B	P	H
S	O	Z	H	A	B	I	T	A	Ç	Ã	O
P	H	O	R	I	Z	O	N	T	E	F	H
E	L	C	O	E	H	E	L	E	N	A	B
H	U	M	O	R	H	O	M	E	M	R	T
E	V	H	O	J	E	H	Á	L	I	T	O
G	H	É	L	I	O	J	S	D	F	G	Q
T	O	M	H	E	R	Ó	I	A	N	G	O
M	A	L	H	O	N	E	S	T	O	K	F
P	S	Z	X	H	Ó	S	P	E	D	E	B

LEITURA

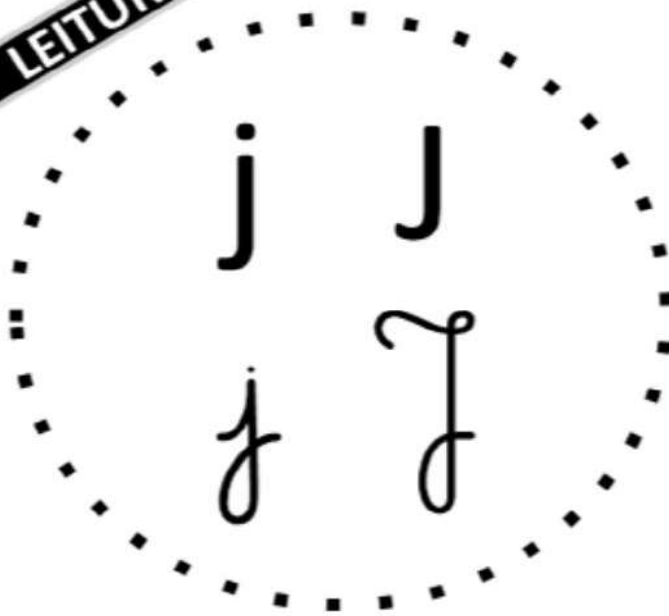

JACARÉ

ja- je- ji- jo- ju

JA- JE- JI- JO- JU

ja- je- ji- jo- ju

Ja- Je- Ji- Jo- Ju

JANELA	JUJUBA	AJUDA
JOIA	JACARÉ	CAJÚ
JUNHO	JUDÔ	JANGADA
JOGO	JANTA	FEIJÃO
JACA	JIBOIA	JORNAL

O JACARÉ TEM O PAPO AMARELO.

JA JE JI JO JU JÃO

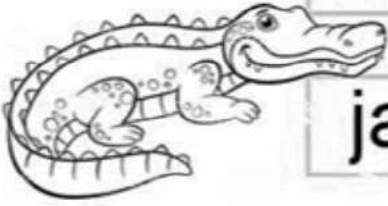

ja je ji jo ju jão

COMPLETE AS PALAVRAS COM AS SÍLABAS
CORRESPONDENTES.

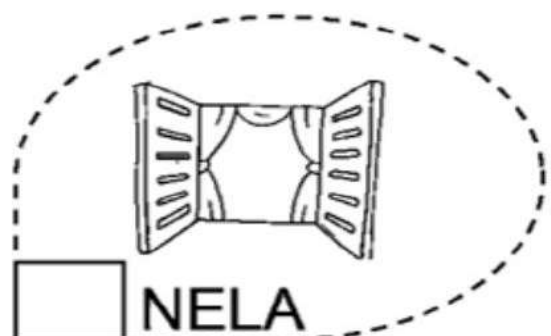
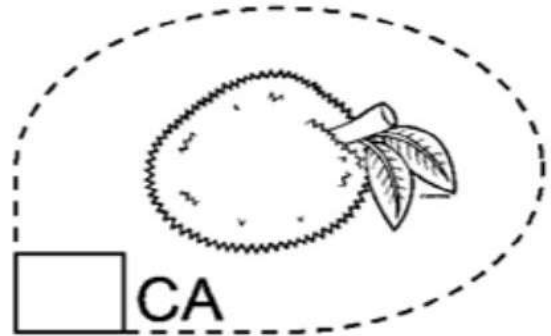

Cubra a família silábica da letra J j.

Ja Je Ji Jo Ju

ja je ji jo ju

Ja Je Ji Jo Ju

ja je ji jo ju

ja je ji jo ju





Ja - Je - Ji - Ju - Ju

ja - je - ji - je - ju

jacaré - jempape - jiboa

jeia - jumento



JIBOIA	JOTA	FEIJÃO	CAJADO
CAJÚ	JOIA	JACA	JUBA

COM O APOIO DO BANCO DE PALAVRAS ACIMA,
COMPLETE A CRUZADINHA:

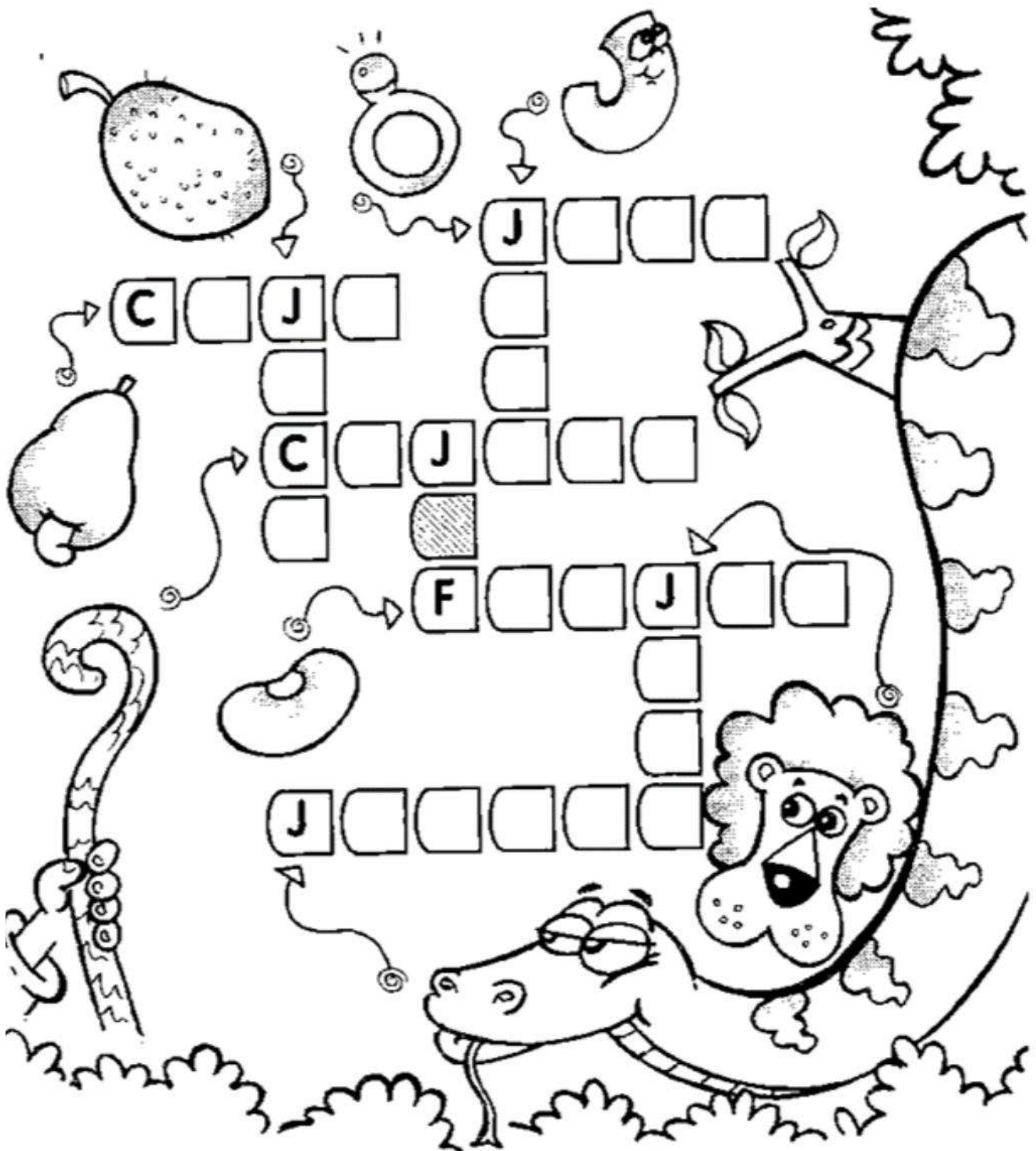

PINTE COM CORES IGUAIS OS QUADRINHOS QUE FORMAM O NOME DE CADA DESENHO:

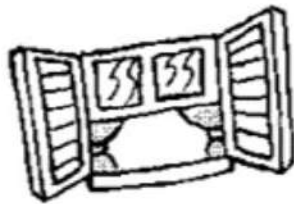
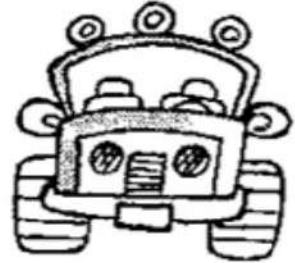
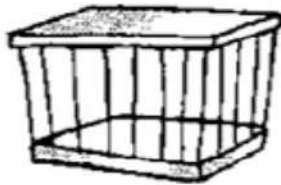

PA	PA	JU	JAU	JA	FEI
RÉ	GAI	JÃO	CA	O	LA
JI	NE	PE	JA	LA	CA

LEITURA



LEÃO

la- le- li- lo- lu
LA- LE- LI- LO- LU
la- le- li- lo- lu
La- Le- Li- Lo- Lu

LUA	LEÃO	LEGO
LEME	LÁPIS	LIMÃO
LOBO	LEVE	LIXO
LAMA	LILÁS	LEME
LAILA	LATA	LOUSA

O LEÃO É O REI DOS ANIMAIS



LA

LE

LI

LO

LU

LÃO

la

le

li

lo

lu

lão

COMPLETE AS PALAVRAS COM AS SÍLABAS
CORRESPONDENTES.

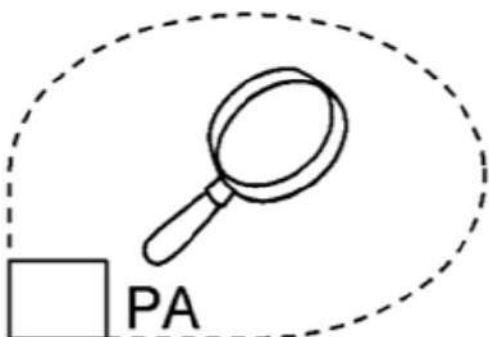
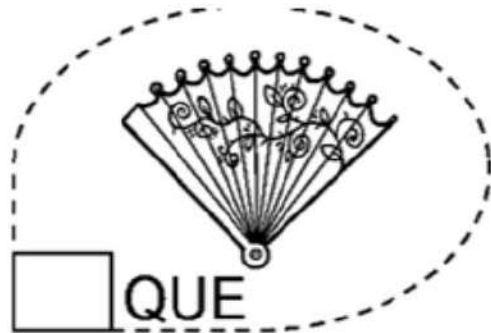
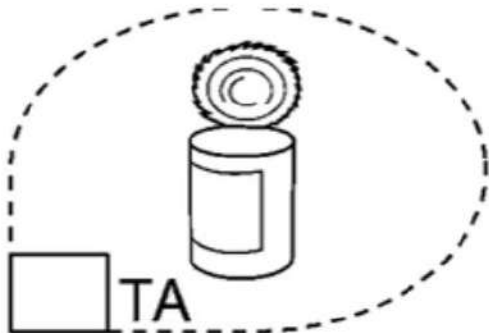

Cubra a família silábica da letra *l*.

la le li lo lu

la le li lo lu



la le li lo lu

la le li lo lu



la le li lo lu



La - Le - Li - Lo - Lu

la - le - li - lo - lu

lápiz - kite - libro

lobo - lua



JUNTE AS SÍLABAS E FORME O NOME DAS FIGURAS:

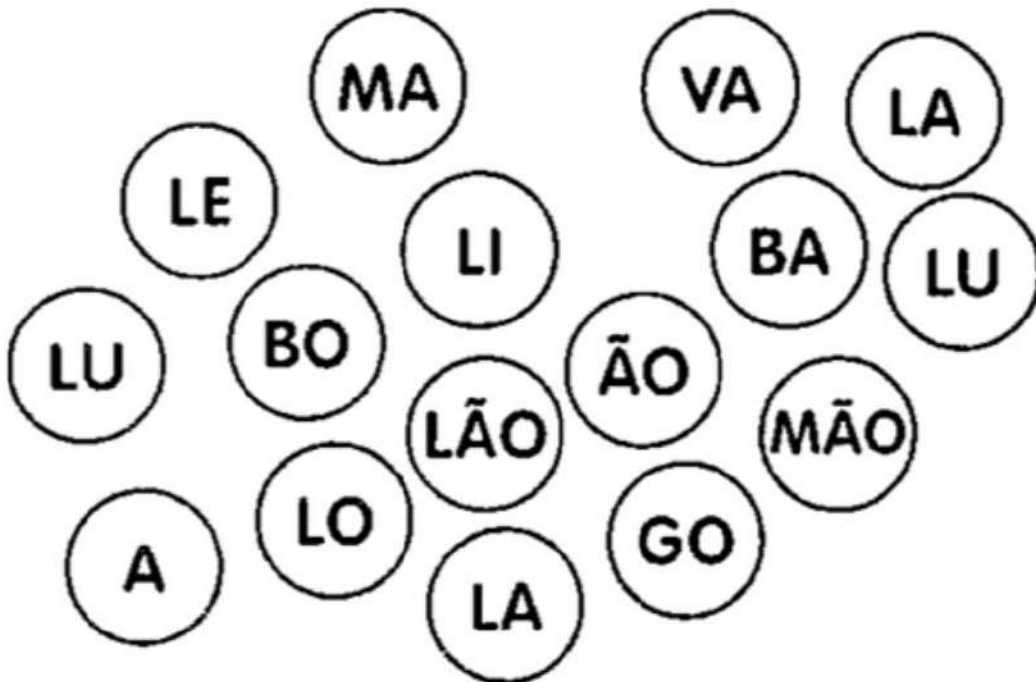

BALEIA	LAGOA	LEÃO	JAULA
LUA	LUVA	GALO	GAIOLA

COM O APOIO DO BANCO DE PALAVRAS ACIMA,
COMPLETE A CRUZADINHA:

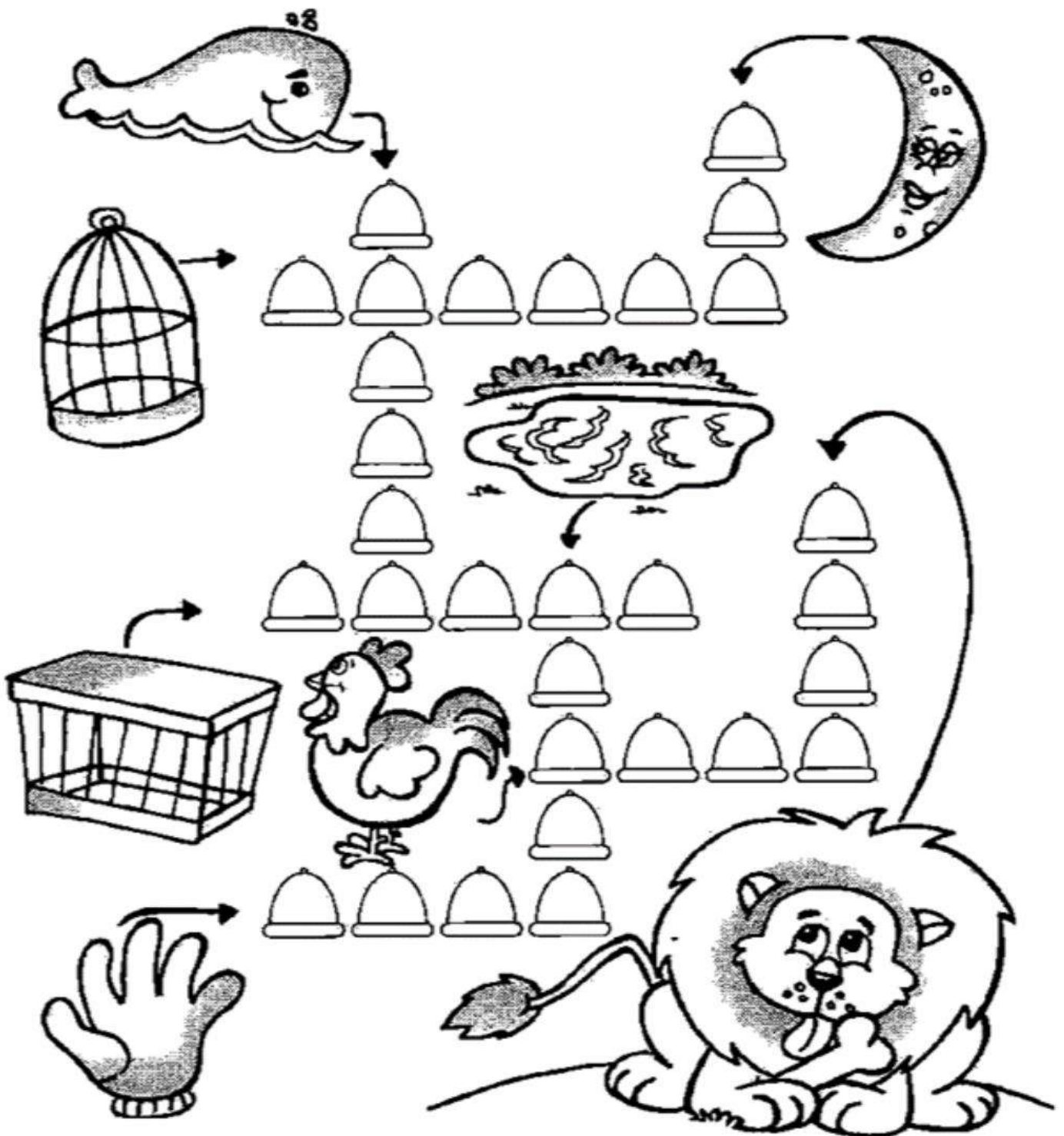

LEITURA

m M

m M

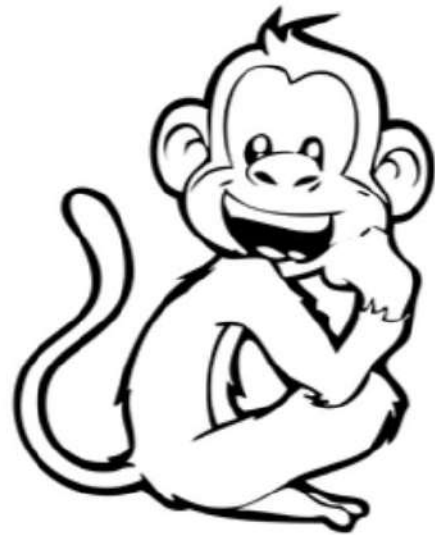

MACACO

ma- me- mi- mo- mu

MA- ME- MI- MO- MU

ma- me- mi- me- mu

Ma- Me- Mi- Me- Mu

MACACO	MEDO	MURO
MALA	MARIDO	MÚSICA
MEIA	MODA	MESADA
MICO	MESA	MACA
MOLA	MAR	MIOLO

O MACACO É MUITO SAPECA.



MA

ME

MI

MO

MU

MÃO

ma

me

mi

mo

mu

mão

COMPLETE AS PALAVRAS COM AS SÍLABAS
CORRESPONDENTES.

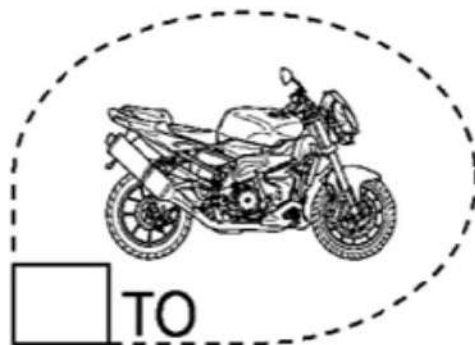
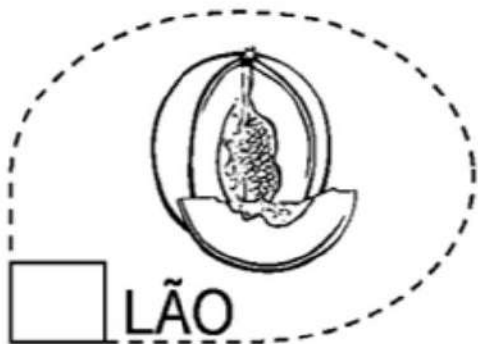
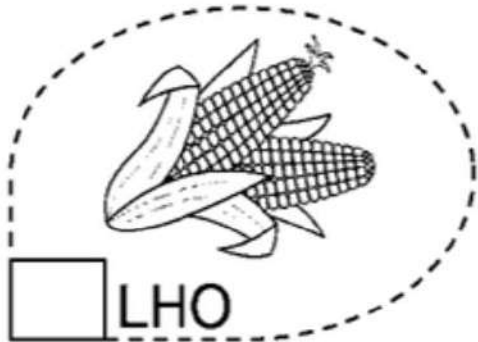
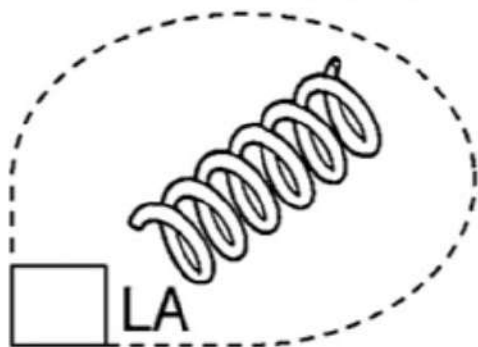

Cubra a família silábica da letra m f.

Ma Me Mi Mo Mu

ma me mi mo mu

Ma Me Mi Mo Mu

ma me mi mo mu

Ma Me Mi Mo Mu





Ma - Me - Mi - Mo - Mu

ma - me - mi - mo - mu

mala - menino - mina

mãe - música



CACA-PALAVRAS

M A C A C O P M I M
E M A G W C B M J U
L A M A R P Q O H L
A F A B O K G T G A
D W N S A O Q O F P
O T S W P M Q C L Q
M Y P M E A X A L M
T P Q O W L Y X K O
C R V L R A Z R D L
A S W A M T T W R E
M T X K L W R V K T
A P O W J W M A T O



MACACO
LAMA
CAMA
EMA
MATO
MULA

MALA
MELADO
MOTOCA
MOLA
MOLE

MAPA	MILHO	MALA	MACACO	MAMADEIRA
MOLA	MAÇÃ	MÃO	MARTELO	MORANGO

COM O APOIO DO BANCO DE PALAVRAS ACIMA,
COMPLETE A CRUZADINHA:

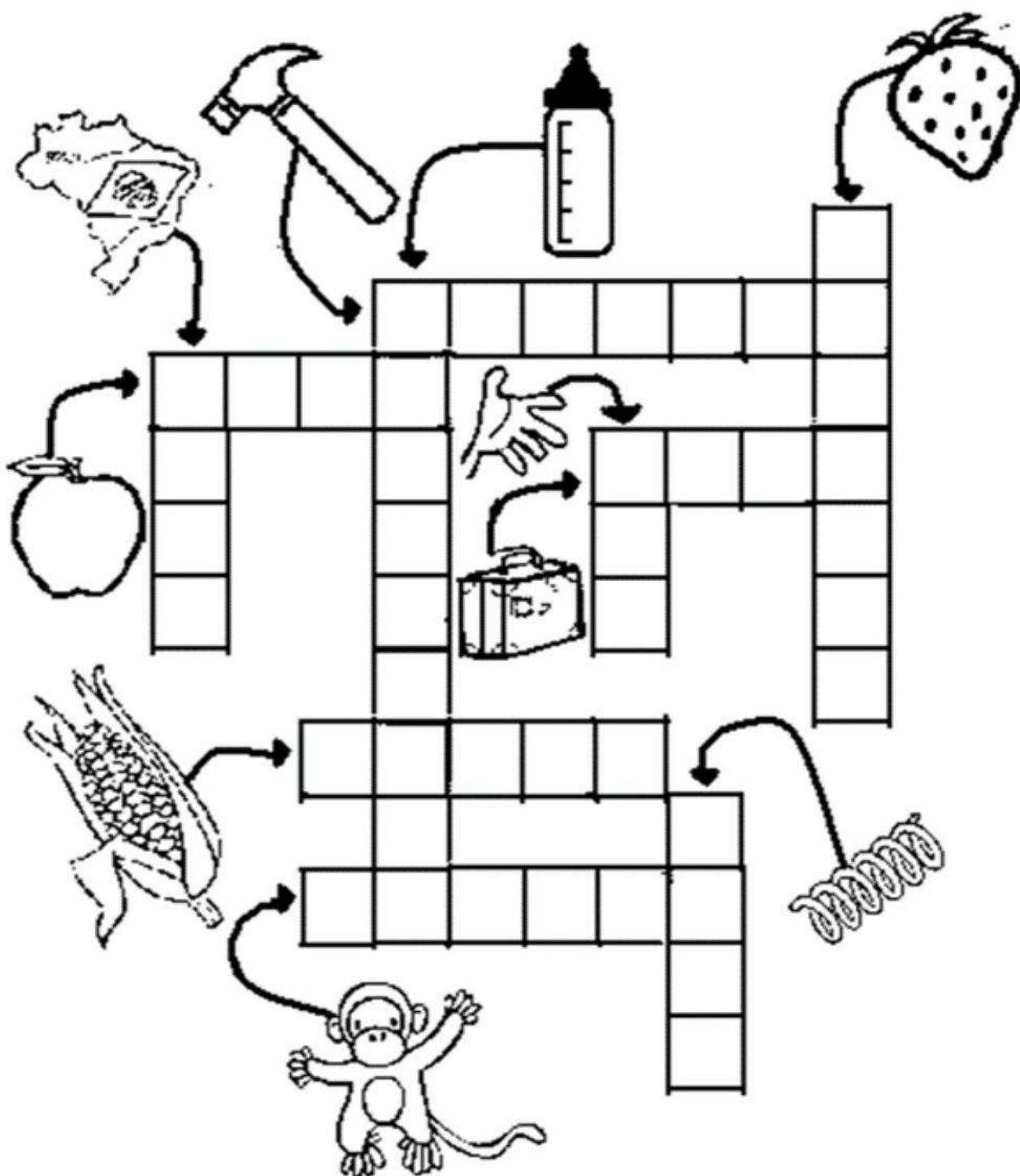

LEITURA



NAVIO

na- ne- ni- no- nu
NA- NE- NI- NO- NU
na- ne- ni- no- nu
Na- Ne- Ni- No- Nu

NAVIO	NABO	BONECA
NOME	NOITE	BANANA
NAVE	NOVELO	CANECA
NUVEM	NICOLE	CANOA
NEVE	NOVELA	NATALIA

O NAVIO JÁ SAIU DO PORTO.

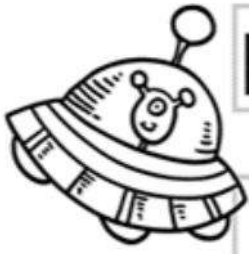

NA NE NI NO NU NÃO

na ne ni no nu não

COMPLETE AS PALAVRAS COM AS SÍLABAS
CORRESPONDENTES.

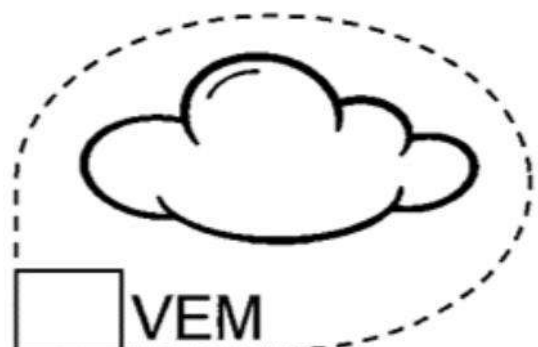

Cubra a família silábica da letra n m.

na ne ni no nu

na ne ni no nu

na ne ni no nu

na ne ni no nu

na ne ni no nu

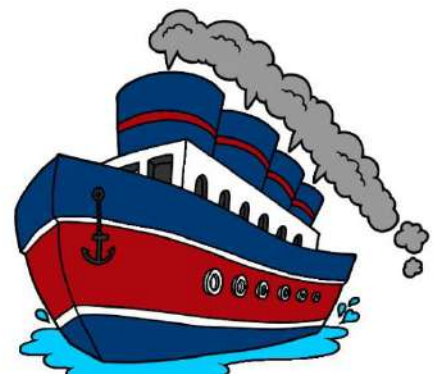



Ma — Me — Mi — Mo — Mu

ma — me — mi — mo — mu

maria — meire — minha

menidade — murem



CAÇA-PALAVRAS

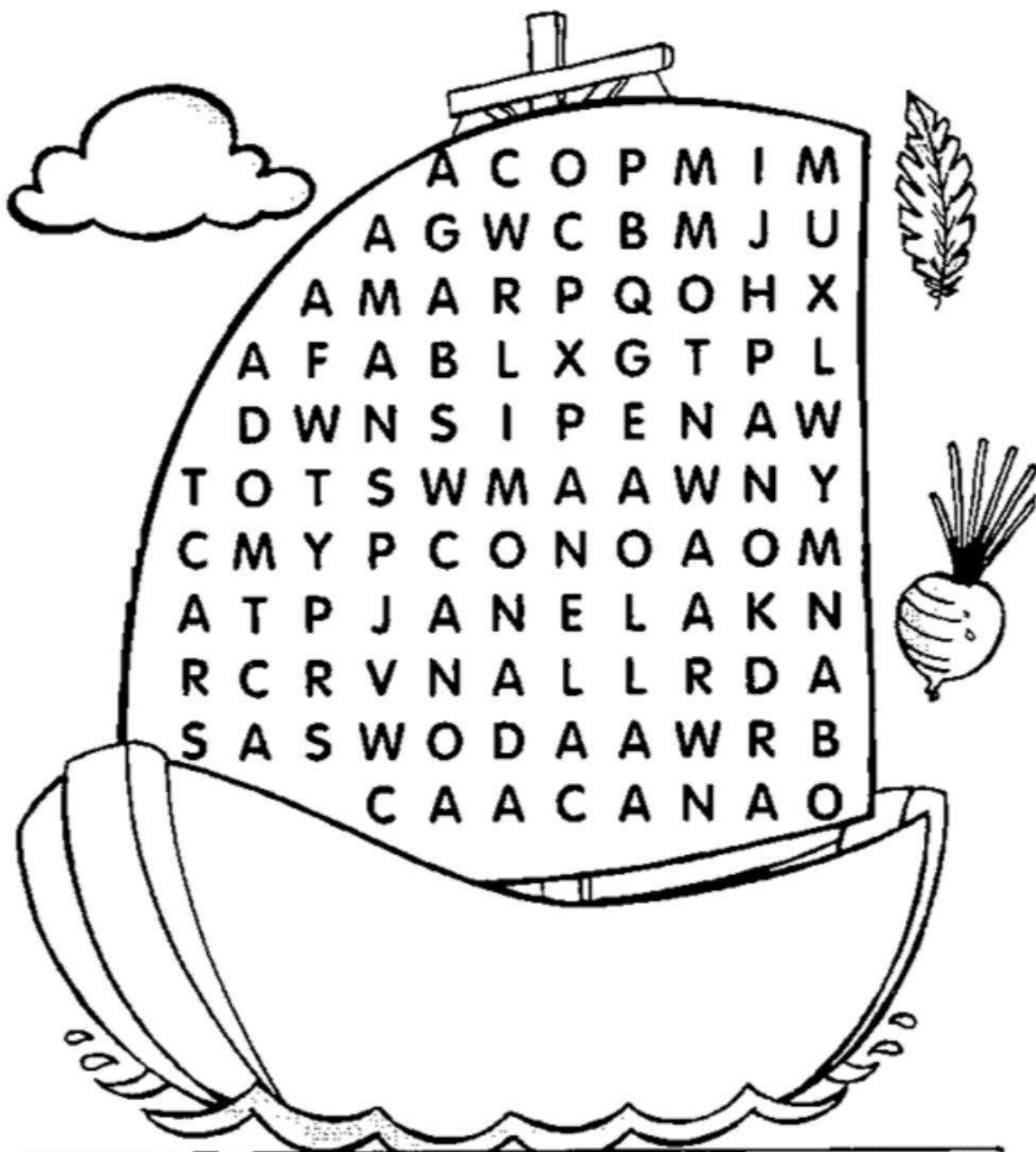

CANOA, LIMONADA, CANA, PANELA,
NABO, PENA, JANELA, PANO

DITADO DE CARTAS

RECORTE AS PALAVRAS ABAIXO E COLE-AS NOS DESENHOS, DE ACORDO COM OS SÍMBOLOS:

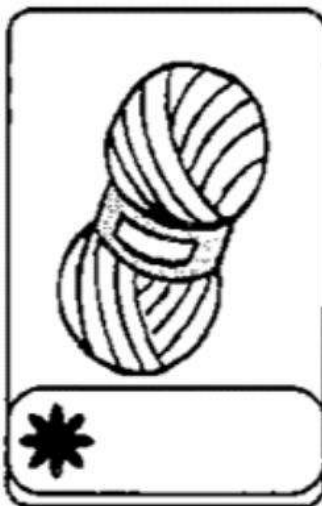
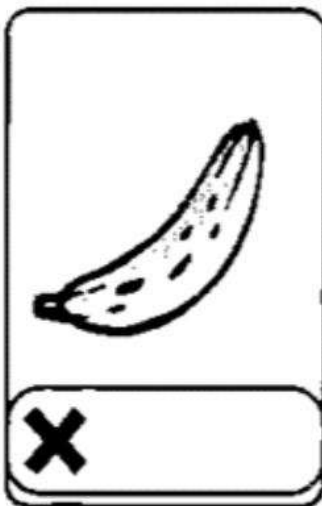
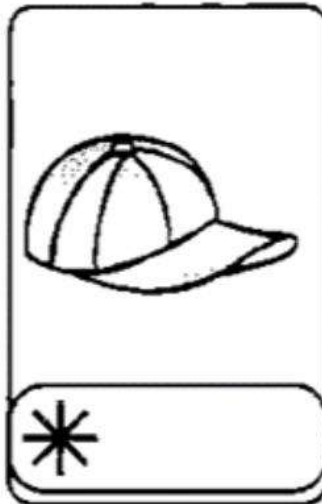
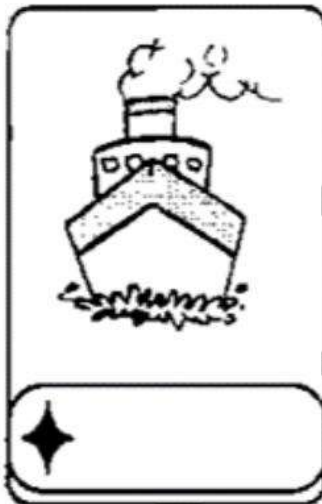

✂
→ CANECA ☾ TUCANO ★ CANETA ✱ BONÉ
○ PIANO ✱ NOVELO ✦ NAVIO ✕ BANANA

LEITURA

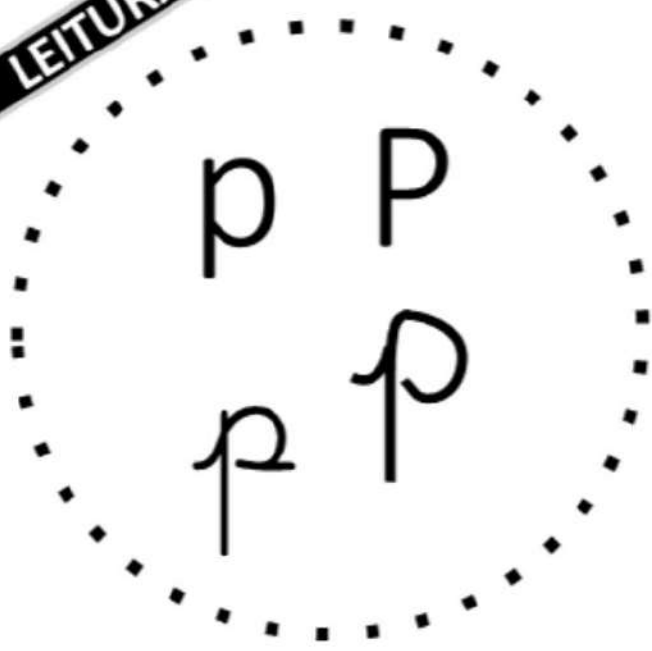

PATO

pa-pe-pi-po-pu
 PA-PE-PI-PO-PU
 pa-pe-pi-pe-pu
 pa-pe-pi-pe-

PICO	POTE	PIRULITO
PATO	PESCA	PICADA
PÊRA	PAULA	PORCO
PUXA	PARA	PENTE
POÇO	PINO	POUCO

DONA PATA É UMA ÓTIMA MAMÃE.



PA PE PI PO PU PÃO

pa pe pi po pu pão

COMPLETE AS PALAVRAS COM AS SÍLABAS
CORRESPONDENTES.

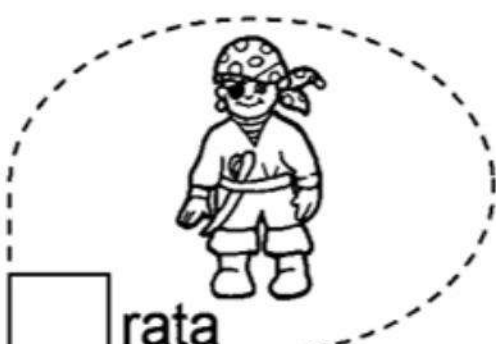
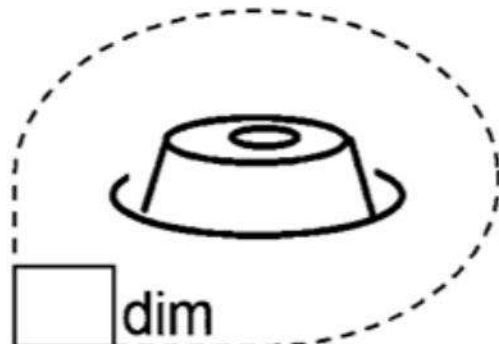
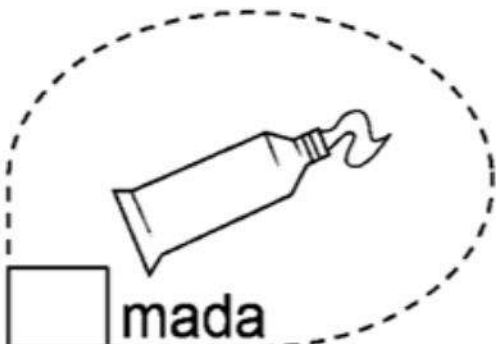
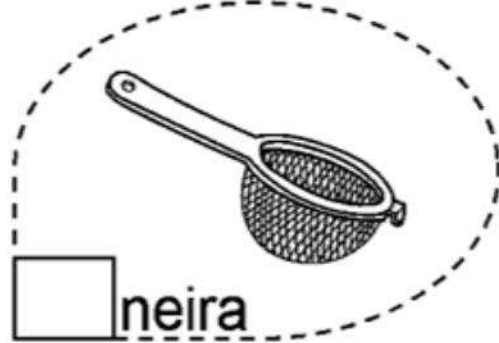
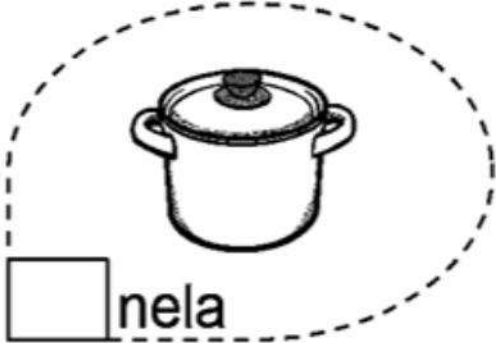
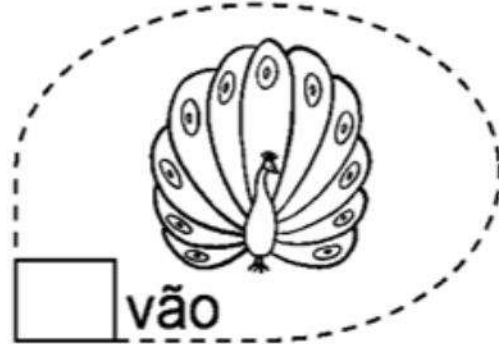
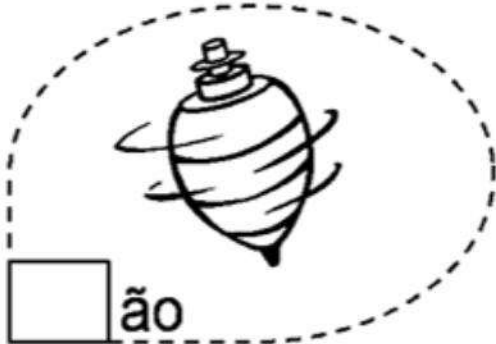



Cubra a família silábica da letra P p.

Pa Pe Pi Po Pu

Pa Pe Pi Po Pu

pa pe pi po pu

pa pe pi po pu

pa pe pi po pu





Pa - Pe - Pi - Po - Pu

pa - pe - pi - po - pu

pate - pema - pirulite

pema - pudim



CAÇA-PALAVRAS



PIPOCA, PIADA, PIRULITO, PAPO,
PAPAI, PATA, PICOLÉ

PAPAGAIO	CAPA	PANELA	COPO
MAPA	PIA	PATO	PALITO

COMPLETE A CRUZADINHA:

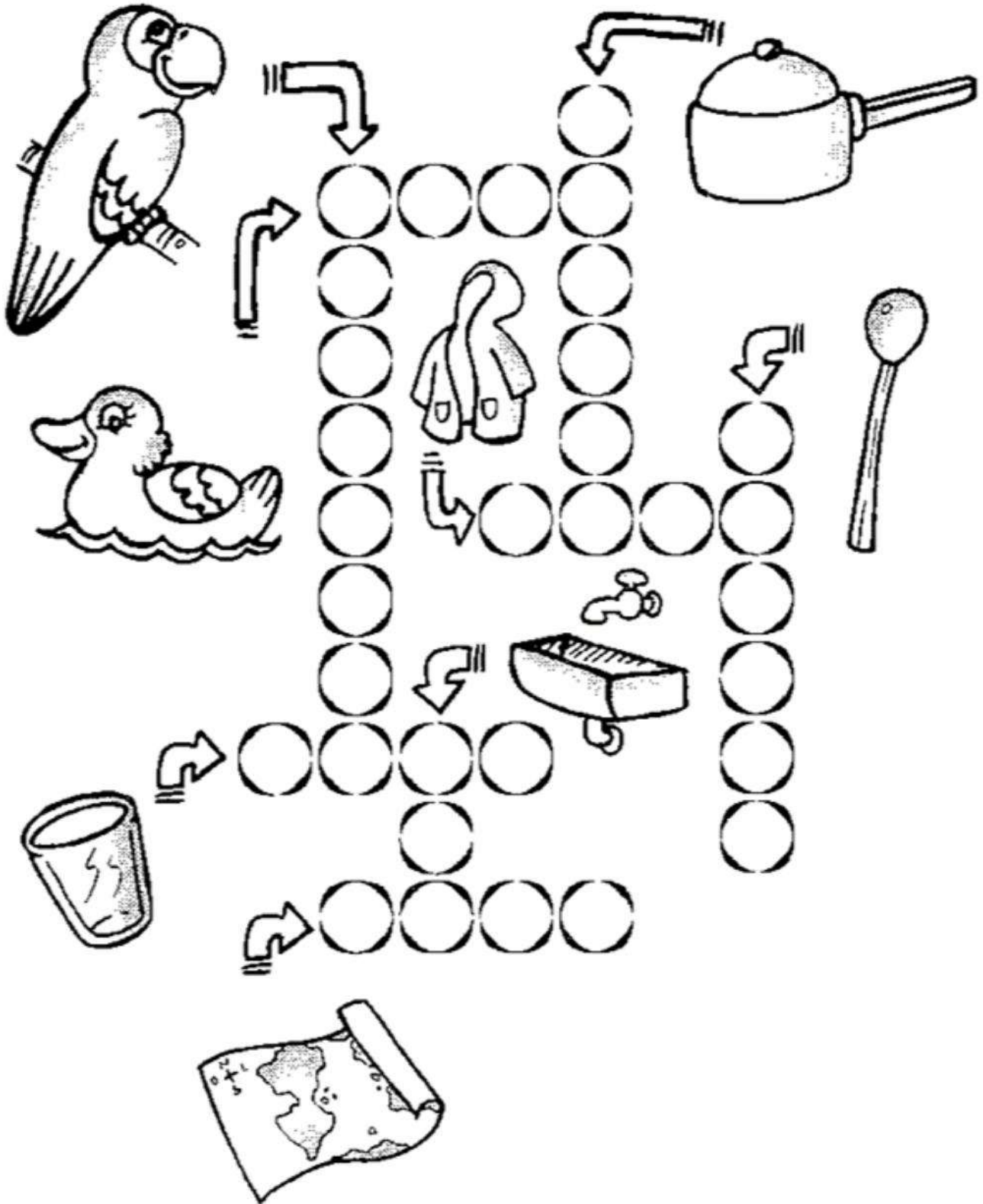

LEITURA

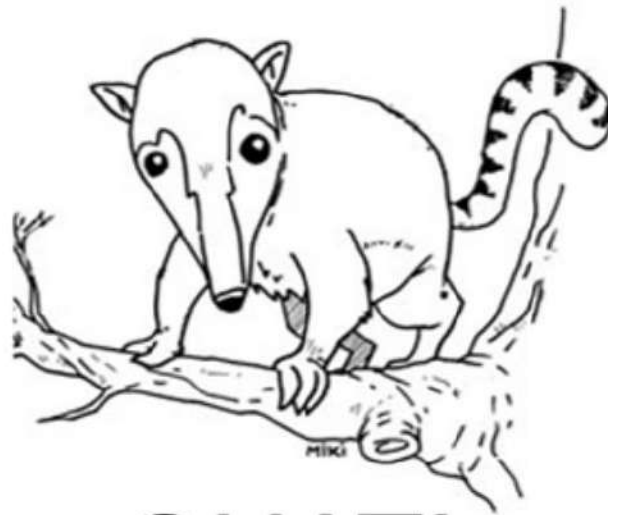
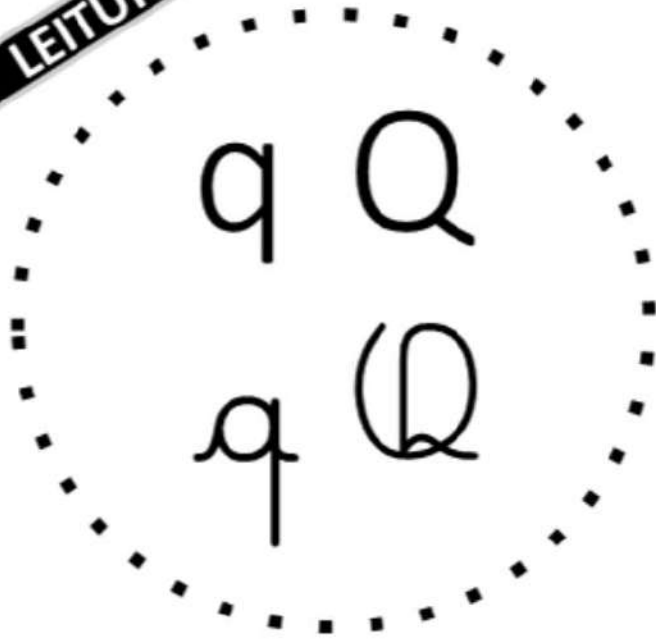

QUATI

- qua- que- qui- quo
- QUA- QUE- QUI- QUO
- *qua- que- qui- que*
- *Qua- Que- Qui- Quo*

QUATI	QUILO	QUALIDADE
QUERO	QUEDA	QUEIJO
QUOTA	QUITAR	QUIABO
QUASE	QUILOMBO	QUATRO

FABIO VIU UM QUATI NA ÁRVORE

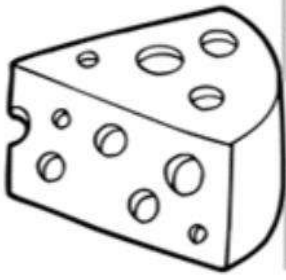

QUA

QUE

QUI

QUO

qua

que

qui

quo

COMPLETE AS PALAVRAS COM AS SÍLABAS
CORRESPONDENTES.



ABO

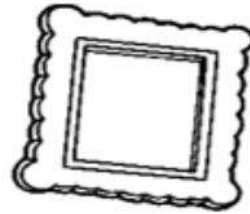

DRO

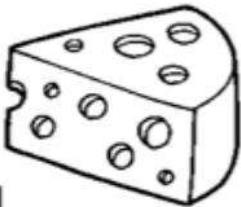

IJO



NDIM



DRADO



RUBIM



TI



BE

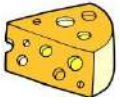

Cubra a família silábica da letra Q q.

Qua Que Qui Quo

Qua Que Qui Quo

qua que qui quo

qua que qui quo

qua que qui quo

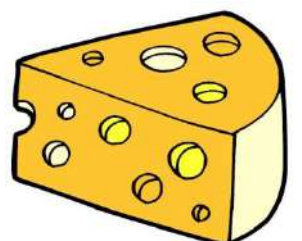



Qua - Que - Qui - Quo

qua - que - qui - quo

quatro - queijo

quilo - quota



PINTE AS SÍLABAS QUE FORMA O NOME DOS DESNEHOS
E COPIE:

QUI	CI
DO	A
BO	TA



PO	CE
QUEI	BO
GO	JO



CE	LE
LO	BE
QUE	JO

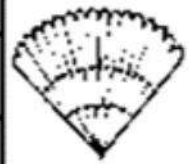



CI	SA
CA	TA
BI	QUI



BU	TO
CE	QUÊ
XO	PE



CO	O
CE	QUEI
RO	BO

BI	QUIN
ZI	DO
DIM	XA



TA	ES
QUI	BI
SE	LO



PE	TI
RI	QUI
TO	BO



JUNTE AS SÍLABAS E FORME PALAVRAS:

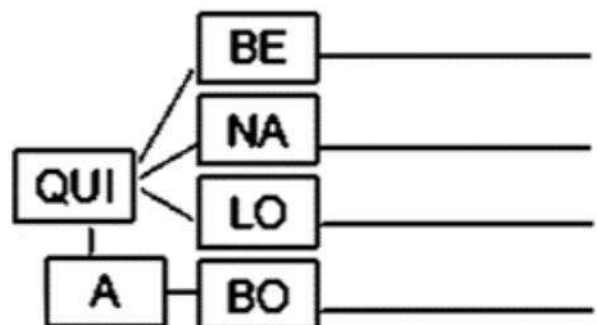
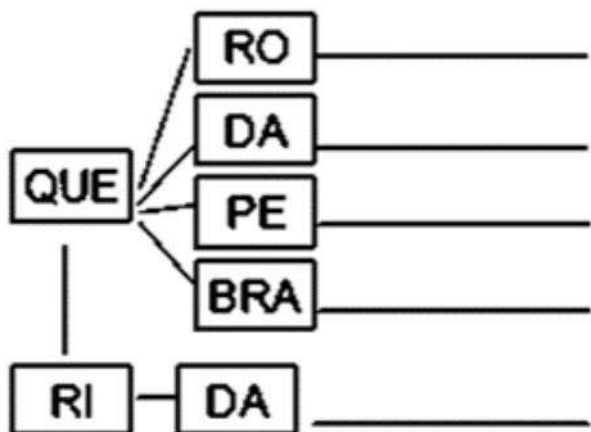

LEITURA



RATO

- ra- re- ri- ro- ru
- RA- RE- RI- RO- RU
- ra- re- ri- ro- ru
- Ra- Re- Ri- Ro- Ru

RATO	RUA	RIO
REDE	ROSA	RODA
REMO	ROMÃ	RENATO
RABO	RAIVA	RODO
RISADA	RECREIO	ROSELI

O RATO ROEU A ROUPA
DO REI DE ROMA.

RA RE RI RO RU RÃO

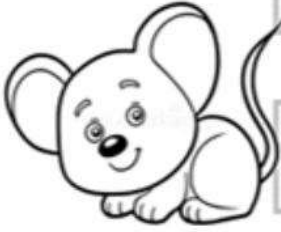

ra re ri ro ru rão

COMPLETE AS PALAVRAS COM AS SÍLABAS
CORRESPONDENTES.

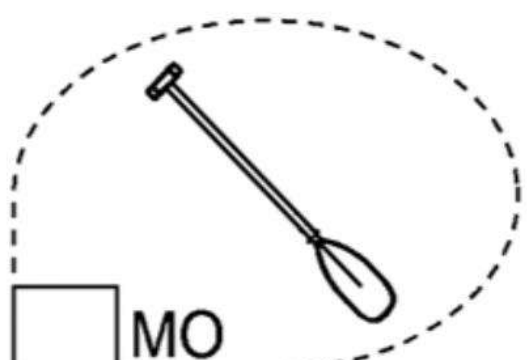
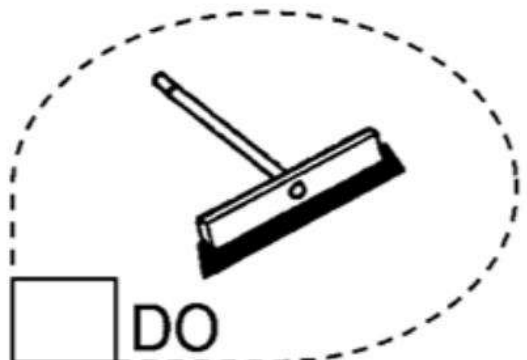
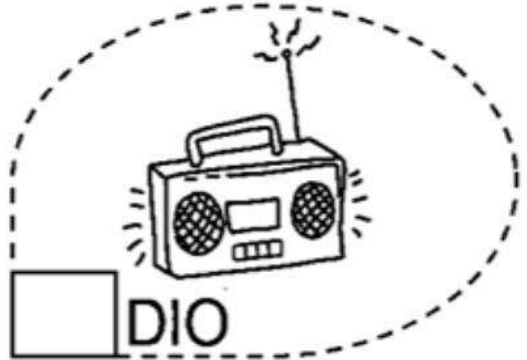
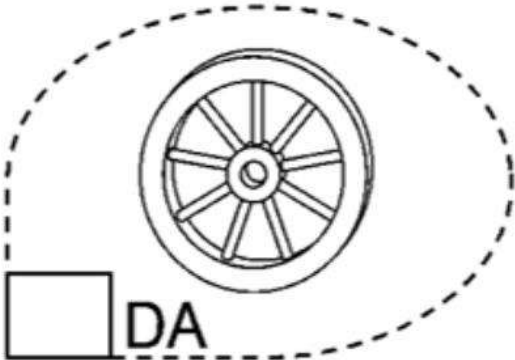
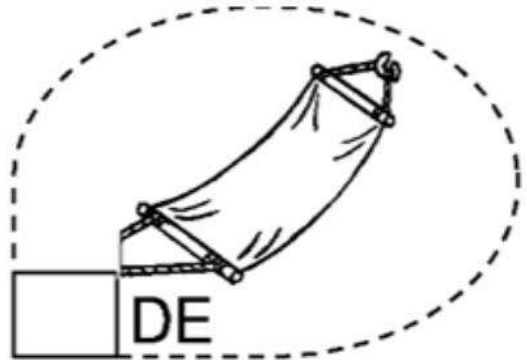
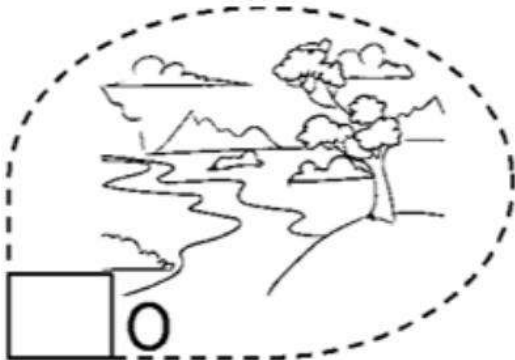



Cubra a família silábica da letra R r.

Ra Re Ri Ro Ru

Ra Re Ri Ro Ru

ra re ri ro ru

ra re ri ro ru

ra re ri ro ru





Ra — Re — Ri — Ro — Ru

ra — re — ri — ro — ru

rato — relógio — rinoceronte

robô — rua



CACA-R

B F C Z R X P M I D G
C G R R N C R L J B C
F R O U X P A K H Q D
R A L G L K L X G P U
Q I A A A R O D A P G
R O S J K U M P X Q Z
M Y R O D A D A T H L
T P Q R I F A S V B N
E Q R U A R Y B Z Q S
D C F P L W N J H G Y
S B M L P T R W Q P K

ROLA, RAIO, RUGA,
RODADA, RIFA, RUA,
RALO, RODA



PINTE AS FIGURAS QUE SE INICIAM COM O SOM
DAS SÍLABAS EM DESTAQUE:

RA

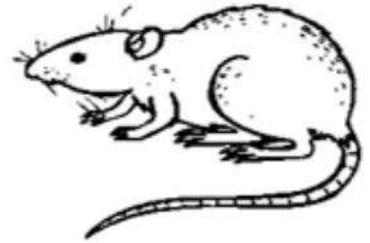
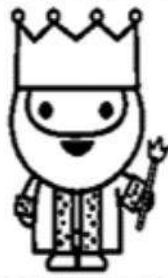

RE



RI



RO

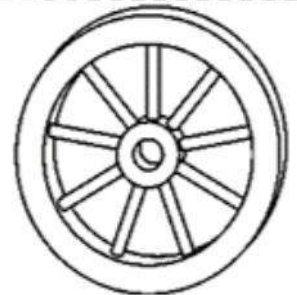
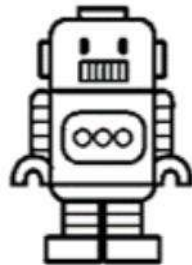

RU

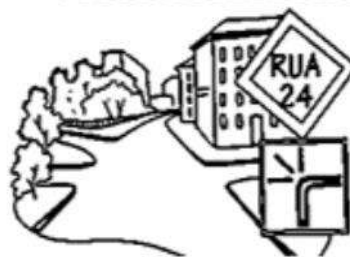

LEITURA



SAPO

- sa- se- si- so- su
- SA- SE- SI- SO- SU
- sa- se- si- so- su
- Sa- Se- Si- So- Su

SAPO	SINO	SOJA
SAL	SAPATO	SEXTA
SEI	SUCO	SÁBADO
SIM	SOM	SUBIR
SOL	SACO	SACOLA

SAPO CURURU ESTÁ COM FRIO.



SA SE SI SO SU SÃO

sa se si so su são

COMPLETE AS PALAVRAS COM AS SÍLABAS CORRESPONDENTES.

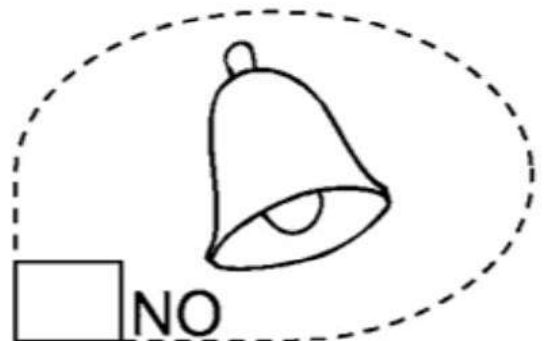
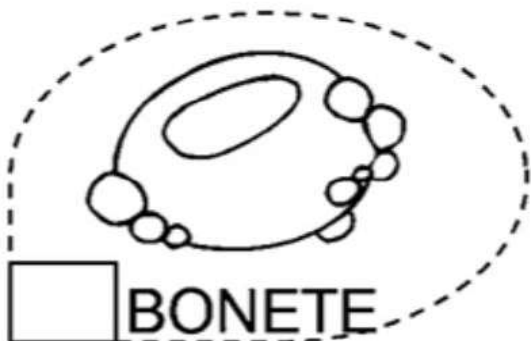
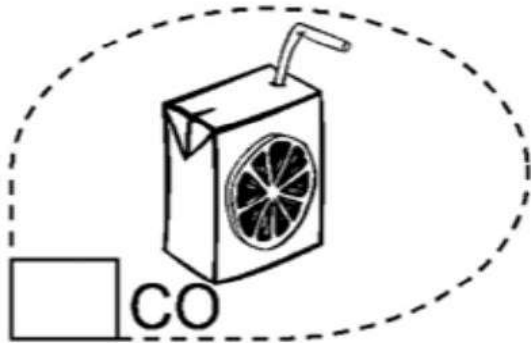



Cubra a família silábica da letra **d** e.

da de di do du

da de di do du

da de di do du

da de di do du

da de di do du





Da - De - Di - Do - Du

sa - se - si - so - su

sapa - sela - sina

sapa - suca



CRUZA-SAPECA

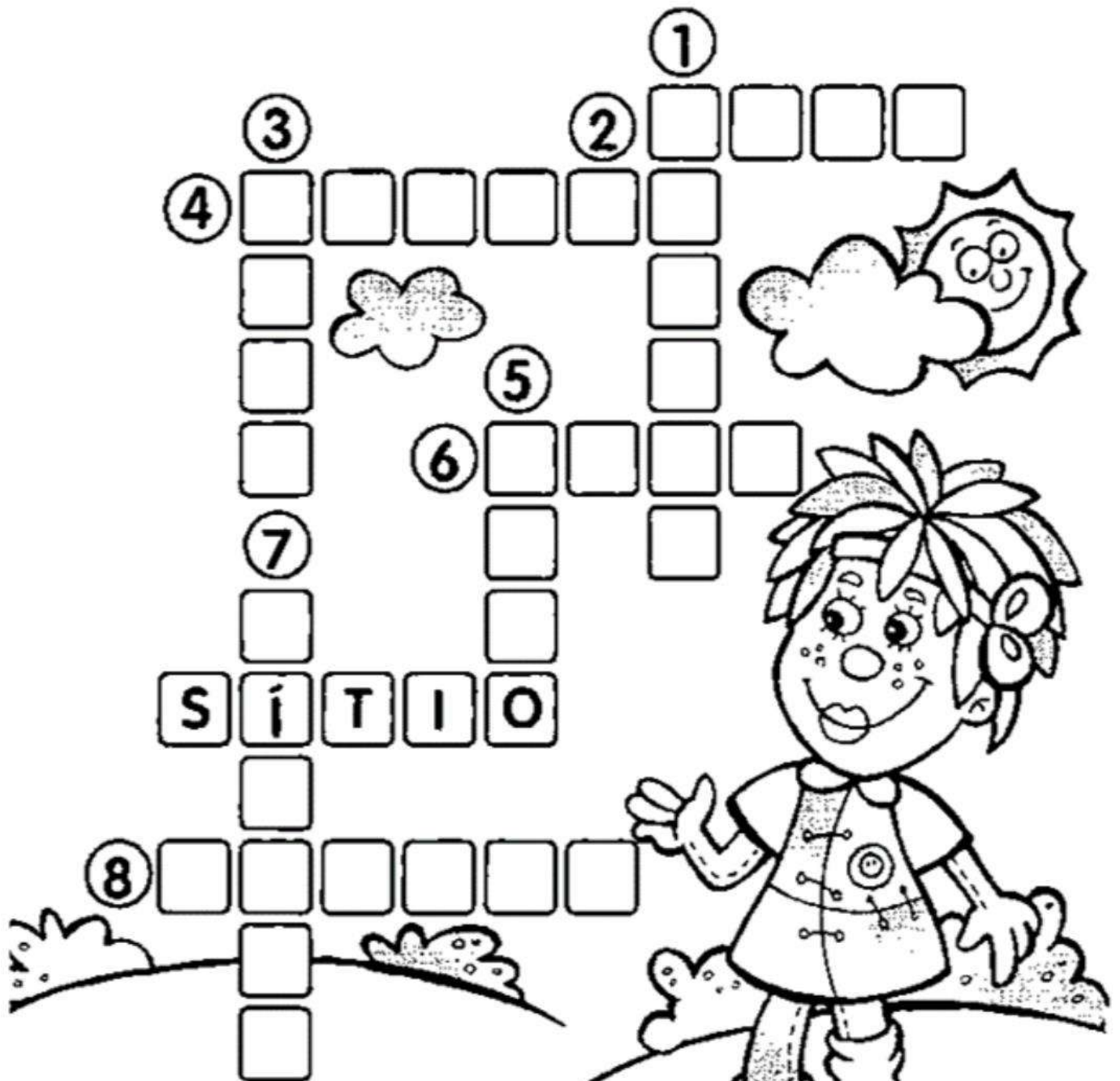

- 1- SOLADO
- 2- SUCO
- 3- SACO
- 4- SAPATO
- 5- SELO

- 6- SEDA
- 7- SÍLABA
- 8- SAPECA

DITADO RECORTADO

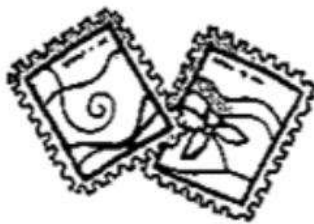

SELO

SOFÁ

SAIA

SUCO

SACO

SINO

SAPO

SAPATO

SACOLA

LEITURA



TATU

ta- te- ti- to- tu
TA- TE- TI- TO- TU
ta- te- ti- to- tu
Ta- Te- Ti- To- Tu

TAPETE	TATU	TUDO
TIPO	TELEVISÃO	TIO
TELEFONE	TUDO	
TOUCA	TOURO	TUBO

O TATU CAVOU SUA TOCA AO LADO
DO PÉ DE LIMÃO.



TA

TE

TI

TO

TU

TÃO

ta

te

ti

to

tu

tão

COMPLETE AS PALAVRAS COM AS SÍLABAS
CORRESPONDENTES.

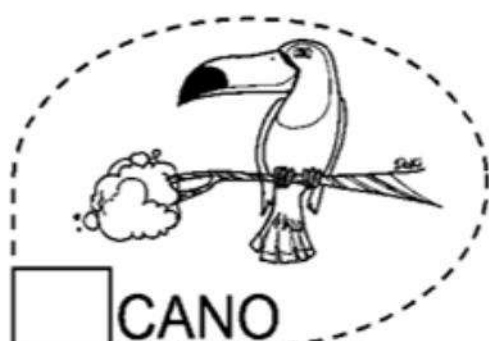
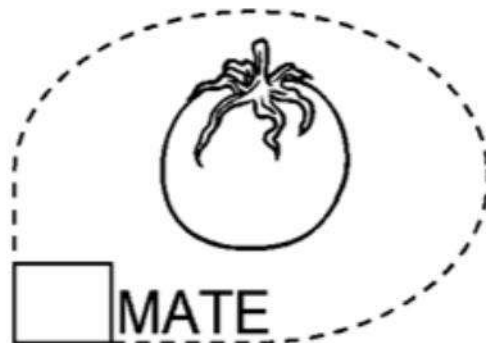

Cubra a família silábica da letra T t.



Ta Te Ti To Tu

Ta Te Ti To Tu

ta te ti to tu

ta te ti to tu

ta te ti to tu





Ta - Te - Ti - To - Tu

ta - te - ti - to - tu

tatu - televisão - time

temada - tudo



CACA - T

B	T	C	Z	Q	X	P
T	Á	V	T	W	P	B
E	B	T	A	R	O	Q
L	U	L	T	L	T	L
E	A	N	U	C	E	A
F	T	S	D	W	F	T
O	Y	R	A	T	O	A
N	P	T	E	T	O	X
E	W	G	A	T	O	M
S	A	P	A	T	O	Z

TELEFONE, TETO, SAPATO, LATA, RATO,
GATO, POTE, TATU, TÁBUA

MOTO	TATU	RATO
TEIA	TAPETE	PATO
SETA	LATA	PETECA

ESCREVA O NOME DAS FIGURAS E SEPRE AS SÍLABAS:











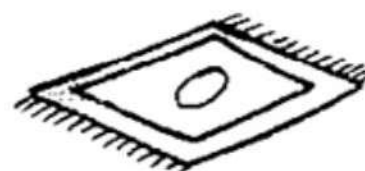







LEITURA

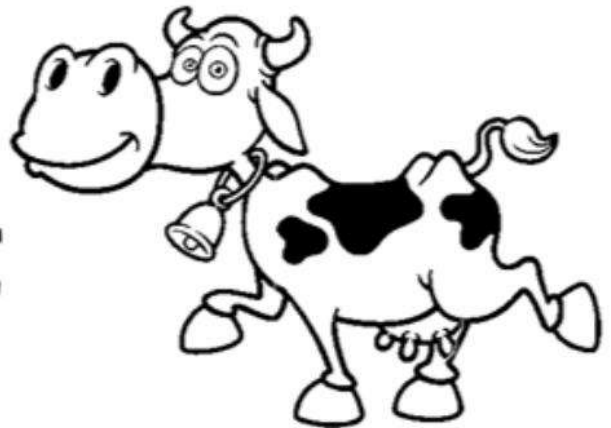

VACA

va- ve- vi- vo- vu

VA- VE- VI- VO- VU

na- ne- ni- no- nu

Ūa- Ūe- Ūi- Ūo- Ūu

VACA	VELA	VOCÊ
VALEU	VULCÃO	VICE
VIVO	VALOR	VILA
VELUDO	VOZ	VOTO

VIVIANE VISITOU O SÍTIO DE SEU
VOVÔ E VIU UMA VACA.



VA VE VI VO VU VÃO

va ve vi vo vu vão

COMPLETE AS PALAVRAS COM AS SÍLABAS
CORRESPONDENTES.

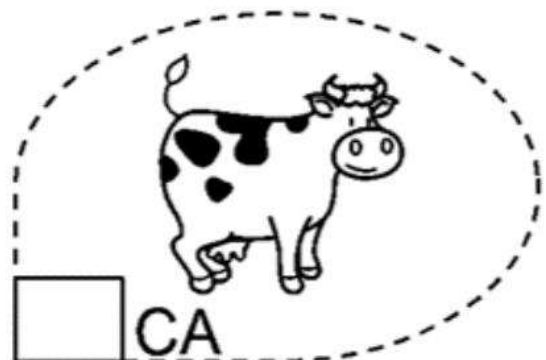
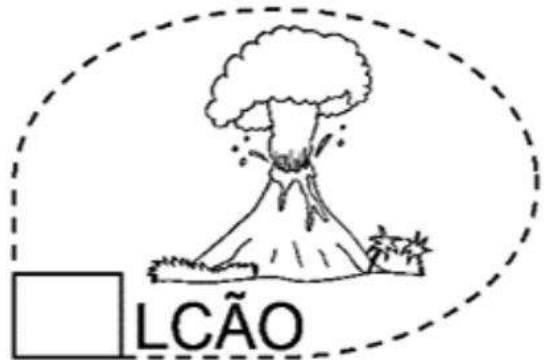

Cubra a família silábica da letra U *u*.



ua ue ui uo uu

ua ue ui uo uu

ua ue ui uo uu

ua ue ui uo uu

ua ue ui uo uu





Ua - Ue - Ui - Uo - Uu

na - ne - ni - no - nu

vaca - vado - vida

vonô - vulcão



CACA-PALAVRAS

B F I Z V X A M I C F H
C V P G A C V I L A N R
F I T R L P I K H Q T S
R D L P A V Ã O G P Y X
Q A N S B V O V Ô P V C
W G V A C A G H M Q K L
M Y V A L E T A B R X Y
T P Q R T Y P S D F G J
E H J K L Z X C V B N M



AVIÃO, VILA, PAVÃO, VOVÓ, VACA,
VIDA, VALETA, VALA

COPIE AS SÍLABAS DOS SÍMBOLOS IGUAIS PARA
FORMAR PALAVRAS:

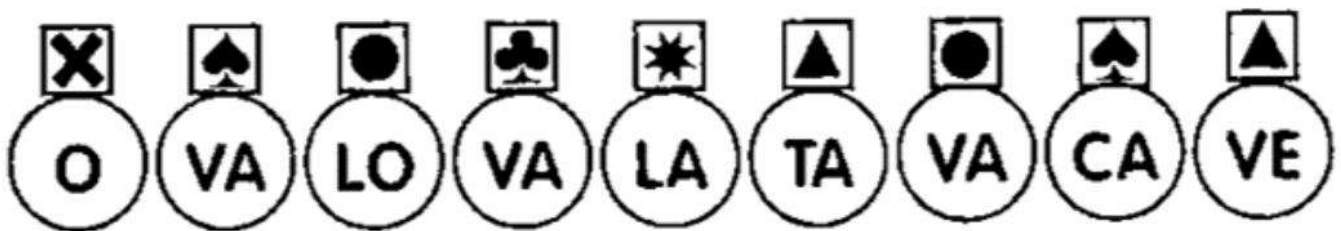
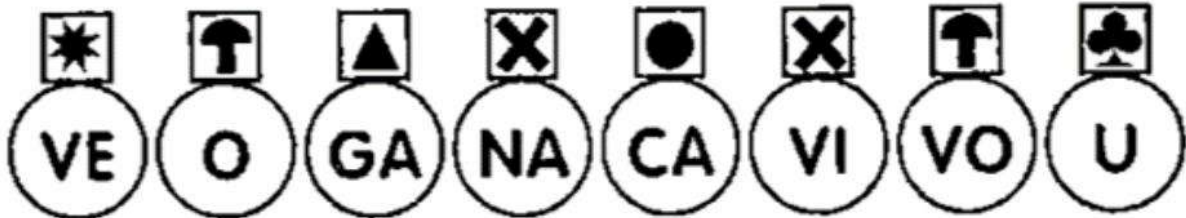

Activity area with four rows of boxes and corresponding illustrations:

- Row 1: Star symbol, 2 boxes, candle illustration, triangle symbol, 3 boxes, box illustration.
- Row 2: Club symbol, 2 boxes, bunch of grapes illustration, tree symbol, 2 boxes, egg illustration.
- Row 3: Circle symbol, 3 boxes, horse head illustration, spade symbol, 2 boxes.
- Row 4: X symbol, 3 boxes, ship illustration, cow illustration.

LEITURA



XÍCARA

xa- xe- xi- xo- xu

XA- XE- XI- XO- XU

xa- xe- xi- xo- xu

Xa- Xe- Xi- Xo- Xu

XALE	XUXA	XÍCARA
XERIFE	XODÓ	ROXO
XERETA	XAROPE	LUXO

A XÍCARA DA VOVÓ É MUITO BONITA.



XA XE XI XO XU XÃO

xa xe xi xo xu xão

COMPLETE AS PALAVRAS COM AS SÍLABAS
CORRESPONDENTES.

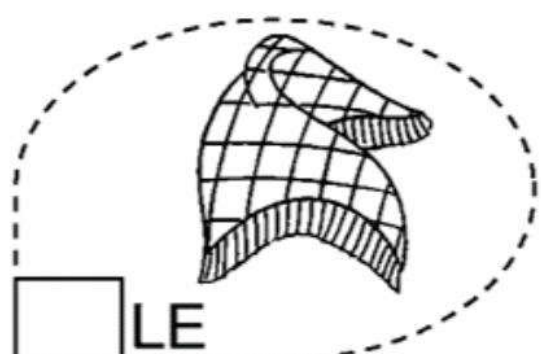
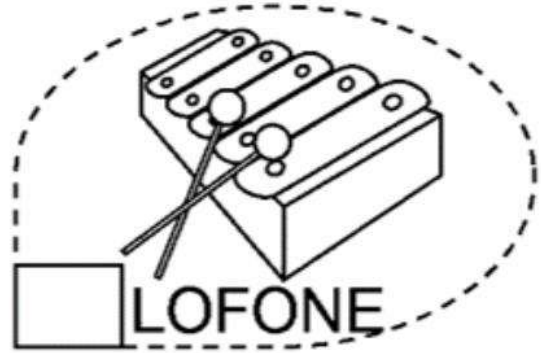



Cubra a família silábica da letra X x.

Xa Xe Xi Xo Xu

Xa Xe Xi Xo Xu

xa xe xi xo xu

xa xe xi xo xu

xa xe xi xo xu





La — Le — Li — Lo — Lu

xa — xe — xi — xo — xu

xarope — xerife — xícara

lixo — Luxa



CAÇA-X

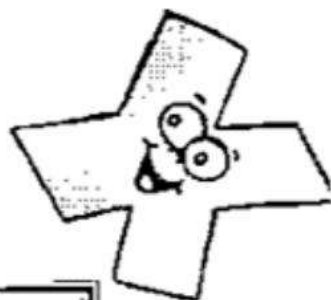

T	B	A	I	X	O	P	M	I	B
C	G	P	C	A	I	X	A	J	E
F	R	T	R	L	I	X	A	H	X
R	Q	L	F	E	I	X	E	G	I
Q	W	R	E	M	E	X	E	F	G
F	A	X	I	N	A	Q	R	T	A
M	L	U	X	O	Y	P	S	D	F
T	P	C	O	X	A	G	L	K	H

BAIXO, CAIXA,
LIXA, FEIXE,
REMEXE, FAXINA,
LUXO, COXA,
BEXIGA

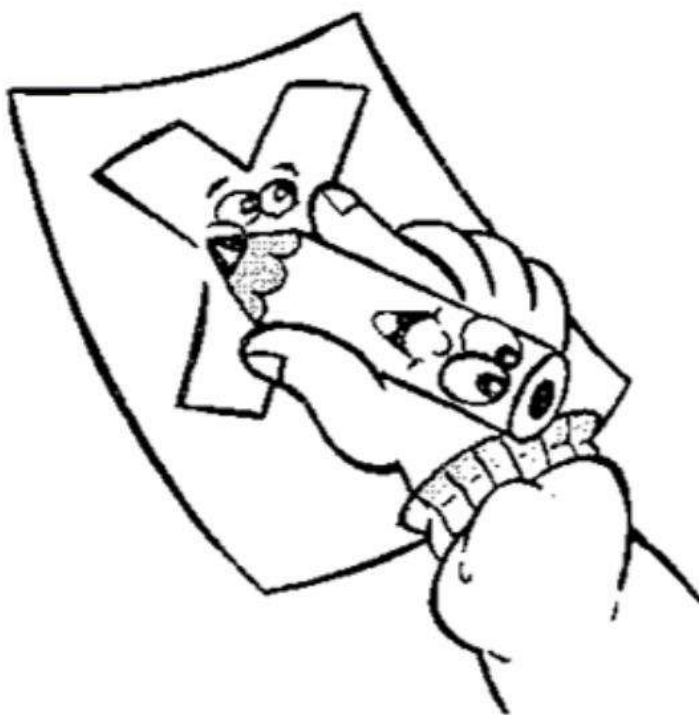

SALADA DE LETRAS

CA
AIX

EP
IXE

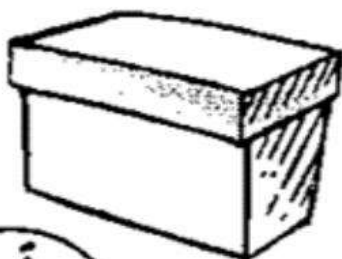

CA
AXR

AP
REO
X



A
ABC
XIA

OX
IL



LEITURA



ZEBRA

za- ze- zi- zo- zu

ZA- ZE- ZI- ZO- ZU

za- ze- zi- ze- zu

Za- Ze- Zi- Ze- Zu

ZEBRA	ZANGÃO	ZUNIDO
ZELO	VAZIO	ZERO
COZINHA	ZUMBI	ZECA

O ZANGÃO É UM DOS AMIGOS
DA ZEBRA ZIZI



ZA ZE ZI ZO ZU ZÃO

za ze zi zo zu zão

COMPLETE AS PALAVRAS COM AS SÍLABAS
CORRESPONDENTES.

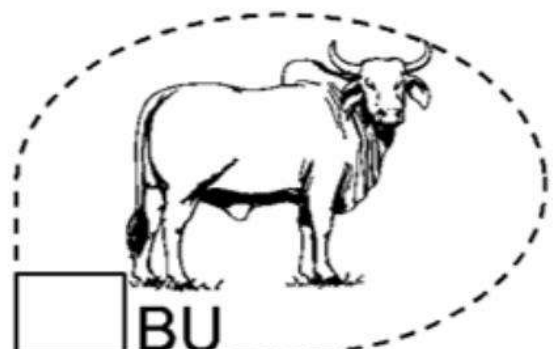
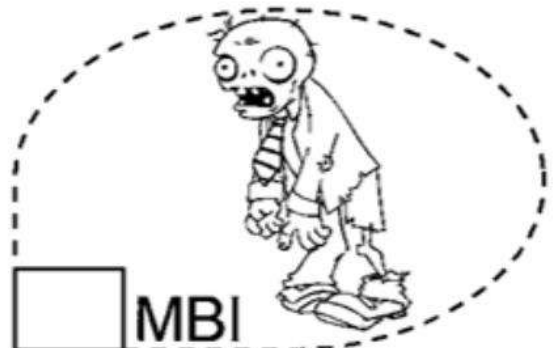



Cubra a família silábica da letra **z** z.

za

ze

zi

zo

zu

za

ze

zi

zo

zu

za

ze

zi

zo

zu

za

ze

zi

zo

zu

za

ze

zi

zo

zu





za — ze — zi — ze — zu

za — ze — zi — ze — zu

zangão — zebra — zíper

zema — zumbi



CAÇA - 2

J B E L E Z A L J B W H
U R T R R P Q K A Z I A
Í Q B B L K G X G P W W
Z W A S J M Q C F P W W
O T T W K N M O L E Z A
M Y I G E L Q Z S V E X
T P Z R P H W I L R B K
E V A Z I O W D W W U W
W N D H B V C O X Z Y T
D Q O R M H J K L Y P R



BELEZA, ZEBU, VAZIO, BATIZADO,
COZIDO, AZIA, MOLEZA, JUÍZO

DITADO NUMÉRICO

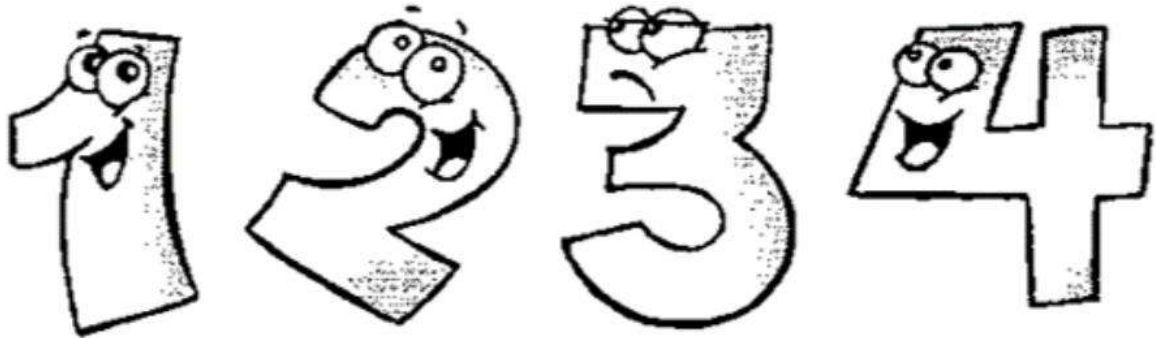

FORME PALAVRAS OBSERVANDO OS NÚMEROS IGUAIS:

1	2	3	4	5	1	3	6	6	4
NA	A	LE	LE	ZE	ZI	ZA	ZEI	A	ZA
7	2	1	4	3	2	5	2	6	7
RO	ZEI	BU	BE	MO	TO	BU	NA	TE	ZE

1

5

2

6

3

7









4



SILABÁRIO SIMPLES

	A 	E 	I 	O 	U 	ÃO
B 	BA	BE	BI	BO	BU	BÃO
C 	CA	CE	CI	CO	CU	CÃO
D 	DA	DE	DI	DO	DU	DÃO
F 	FA	FE	FI	FO	FU	FÃO
G 	GA	GE	GI	GO	GU	GÃO
H 	HA	HE	HI	HO	HU	HÃO
J 	JA	JE	JI	JO	JU	JÃO
K 	KA	KE	KI	KO	KU	—
L 	LA	LE	LI	LO	LU	LÃO
M 	MA	ME	MI	MO	MU	MÃO
N 	NA	NE	NI	NO	NU	NÃO
P 	PA	PE	PI	PO	PU	PÃO
Q 	QUA	QUE	QUI	QUO	—	QUÃO
R 	RA	RE	RI	RO	RU	RÃO
S 	SA	SE	SI	SO	SU	SÃO
T 	TA	TE	TI	TO	TU	TÃO
V 	VA	VE	VI	VO	VU	VÃO
W 	WA	WE	WI	WO	WU	—
X 	XA	XE	XI	XO	XU	XÃO
Y 	YA	YE	—	YO	YU	—
Z 	ZA	ZE	ZI	ZO	ZU	ZÃO

SÍLABAS COMPLEXAS

	AQUÁRIO	QUA	QUE	QUI	QUO	-
	BRAÇO	BRA	BRE	BRI	BRO	BRU
	CRAVO	CRA	CRE	CRI	CRO	CRU
	DRAGÃO	DRA	DRE	DRI	DRO	DRU
	FRALDA	FRA	FRE	FRI	FRO	FRU
	GRAVATA	GRA	GRE	GRI	GRO	GRU
	PRATO	PRA	PRE	PRI	PRO	PRU
	TRATOR	TRA	TRE	TRI	TRO	TRU
	LIVRO	VRA	VRE	VRI	VRO	VRU
	BLUSA	BLA	BLE	BLI	BLO	BLU
	CLARA	CLA	CLE	CLI	CLO	CLU
	FLAUTA	FLA	FLE	FLI	FLO	FLU
	GLOBO	GLA	GLE	GLI	GLO	GLU
	PLACA	PLA	PLE	PLI	PLO	PLU
	ATLETA	TLA	TLE	TLI	TLO	TLU
	VLADMIR	VLA	VLE	VLI	VLO	VLU
	CHAPÉU	CHA	CHE	CHI	CHO	CHU
	ÁRVORE	AR	ER	IR	OR	UR
	GALINHA	NHA	NHE	NHI	NHO	NHU
	COELHO	LHA	LHE	LHI	LHO	LHU
	ESCADA	AS	ES	IS	OS	US
	ANJO	AN	EN	IN	ON	UN
	ALFACE	AL	EL	IL	OL	UL
	FOGUETE	GUA	GUE	GUI	GUO	-